

Form 19094
(937)
Printed in U.S.A.

LIST OF PARTS



SINGER** MACHINES

Nos. 147-104, 147-105, 147-106,
147-107 and 147-108

THE SINGER MANUFACTURING COMPANY

**A Trade Mark of THE SINGER MANUFACTURING COMPANY

INSTRUCTIONS FOR OILING

To ensure easy running and prevent unnecessary wear of the parts which are in movable contact, the machine requires oiling and when in continuous use, "TYPE B" or "TYPE D" OIL, sold by Singer Sewing Machine Company, should be applied at least twice each day to all oil holes marked "OIL", as instructed in Form 19066, Instructions for Using and Adjusting Machines 147-104, 147-105 and 147-108 and in Form 19071, Instructions for Using and Adjusting Machines 147-106 and 147-107.

"TYPE D" OIL should be used when an oil is desired which will produce a minimum of stain on fabrics, even after a long period of storage.

SPECIAL NOTICE

The letter "o", marked on oil pipe couplings must always be at the top. This is to insure that the oil spoon, attached to the inner end of each coupling, is open side up.

INDEX

	Page
Accessories.....	20
Belt Guard.....	20
Bench Stand.....	20
Foot Lifter Parts.....	20
Knee Lifter Parts.....	21
Machine Base.....	21
Machine Base Oil Drain Jar.....	22
Machine No. 147-104.....	5
Machine No. 147-105.....	15
Machine No. 147-106.....	16
Machine No. 147-107.....	17
Machine No. 147-108.....	19
Numerical List of Parts.....	25
Thread Unwinder.....	22

In ordering from this list, use ONLY the part NUMBER in the FIRST column.

The number stamped on a Sewing Machine Part is in every case the number of the single part only.

Every combination of parts sent out as such has its specific number, which, although not stamped on the parts, must be used when ordering the combination.

Each number always indicates the SAME PART in whatever list it appears, or for whatever machine.

The letters after some of the numbers indicate the style of finish only, as follows:

- A-Hardened, Polished, Nickel Plated and Buffed
- B-Polished, Nickel Plated and Buffed
- C-Hardened Only
- D-Polished Only
- E-Soft, Not Polished
- F-Hardened and Polished
- F.J-Hardened, Polished and Nickel Plated
- G-Bright Rumbled and Nickel Plated
- H-Blued
- J-Nickel Plated Only
- K-Hardened and Nickel Plated
- L-Brass Plated
- M-Oxidized
- N-Japanned, Dull
- P-Japanned, Bright
- R-Merlized
- S-Cadmium Plating
- T-Copper Plated
- T.A-Hardened, Polished, Copper and Nickel Plated and Buffed
- T.B-Copper and Nickel Plated and Polished
- T.J-Copper and Nickel Plated Only
- T.K-Hardened, Copper and Nickel Plated
- T.L-Copper and Brass Plated
- T.M-Copper Plated and Oxidized
- U-Zinc Plated
- V-Silver Plated
- W-Polished and Nickel Plated
- X-Black Oxide, for Iron and Steel
- X.C-Hardened and Black Oxide, for Iron or Steel
- Y-Black Nickel Plated Only
- Z-Chromium Plated
- Z.A-Hardened, Polished, Nickel Plated, Buffed and Chromium Plated
- Z.B-Polished, Nickel Plated, Buffed and Chromium Plated
- Z.C-Hardened and Chromium Plated
- Z.J-Nickel and Chromium Plated

These letters MUST BE USED when they appear in the list; and AFTER the number as in the list.

In this series:

- 1 to 1500, 50001 to 51500 and 140001 to 142000 are Screw Numbers
- 1501 to 1800 and 51501 to 51800 are Nut Numbers
- 1801 to 2000 and 51801 to 52000 are Roller Numbers
- 2001 to 50000 and 52001 to 140000 and 142001 to 190000 are Sewing Machine Parts, 190001 and upward are numbers of Electrical Parts.

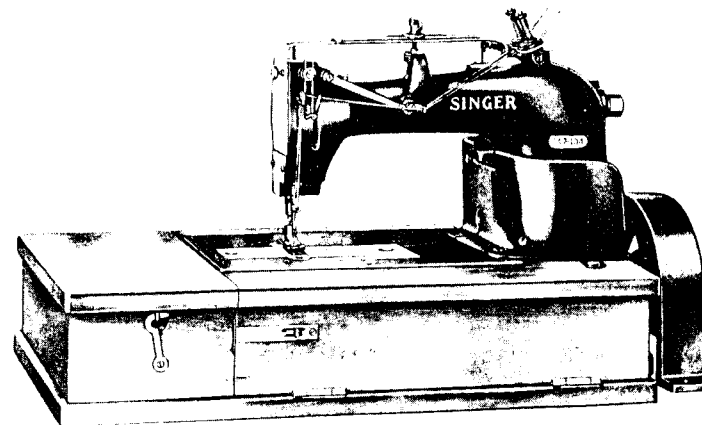
The figures in the second column refer only to the plates, illustrating the parts, and are NOT TO BE USED in ordering.

Parts marked with an asterisk (*) are furnished only when repairs are made at factory.

When ordering parts which differ as to Gauge (the distance between seams) the Gauge, as well as the Number must be given on order.

LIST OF PARTS COMPLETE

FOR



MACHINE No. 147-104

For Seat Seaming Light and Medium Trousers. Two needles, two loopers. Needles set tandem 3/16 inch apart. Ball bearing. Needle bar stroke 1 7/32 inches. The loopers are arranged so that they may be thrown out of position for convenience in threading. An improved oiling system automatically oils all of the principal bearings of the machine. Speed 4000 R. P. M.

No.	Plate	Name
*131446	-----	Arm, upper and lower (solid) with 948J, 15404, 68483, two 15405 and four 131022.....
68428	20529	Arm Bottom Cover.....
68429	20529	" " " Gasket (cork).....
1057C	20530	" " " Screw.....
50608R	20530	" Hole Plug Screw, for access to Crank Connecting Rod (upper bearing).....
139017	20530	Arm Hole Plug Screw Washer.....
68350	20530	" Oil Cup, for oiling Arm Rock Shaft Front Bearing.....

No.	Plate	Name
*68430	-----	Arm Oil Cup, for 131309.....
131309	20529	" " " 68430 with 131310, for filling oil reservoir.....
131305	20529	Arm Oil Cup Drip Pan with two 563C.....
563C	20530	" " " " " Position Screw.....
131319	20530	" " " Oil Pad (braided cotton) for 68350.....
131310	20529	Arm Oil Cup Oil Tube.....
131293	20550	" Rock Shaft.....
131474	-----	" " " 131293 with 1235F, 127838 and 131475.....
1309C	20530	Arm Rock Shaft Adjusting Screw.....
131056	20530	" " " " " Washer....
68433	20550	" " " Bushing (back).....
68435	20550	" " " " " Cap.....
131095	20550	" " " " " Washer (fibre).....
446C	20530	Arm Rock Shaft Bushing (back) Set Screw..
68436	20550	" " " " " (intermediate)....
423C	20530	" " " " " Set Screw.....
131072	20550	Arm Rock Shaft Crank, back (ball bearing, solid) with two 50083C.....
50083C	20530	Arm Rock Shaft Crank (back) Set Screw....
131475	20550	" " " " (front) with 853C...
127838	20530	" " " " " Pin.....
131456	20550	" " " Flanged Bushing (front)...
453C	20600	" " " " " Set Screw.....
42365	20530	Arm Rock Shaft Oil Pad (braided cotton) for oiling Back Bearing.....
54969	20530	Arm Rock Shaft Oil Pad (braided cotton) for oiling Intermediate Bearing.....
1235F	20530	Arm Rock Shaft Oil Plug Screw.....
131476	20599	" Rotary Shaft.....
Note: When No. 131476 is required for repairs, the Looper Driving Shaft and Feed Lifting Eccentric must be returned to the factory to be adjusted to the new part.		
131485	-----	Arm Rotary Shaft 131476 with 640E, 68459, 131111 and 131502.....
131366	20550	Arm Rotary Shaft Ball Bearing (back)....
131478	20529	" " " " " Case.
131479	-----	" " " " " " 131478 with 131369 and three 205C....
131526	-----	Arm Rotary Shaft Ball Bearing (back) Case with Ball Bearings complete, Nos. 131479, 131480 and two 131366.....
131369	20529	Arm Rotary Shaft Ball Bearing (back) Case Cap.....

No.	Plate	Name
205C	20530	Arm Rotary Shaft Ball Bearing (back) Case Cap Screw.....
131370	20530	Arm Rotary Shaft Ball Bearing (back) Case Position Stud.....
429C	20530	Arm Rotary Shaft Ball Bearing (back) Case Set Screw.....
131480	20539	Arm Rotary Shaft Ball Bearing (back) Spacing Collar.....
131366	20550	Arm Rotary Shaft Ball Bearing (intermediate).....
131481	20550	Arm Rotary Shaft Ball Bearing (intermediate) Case.....
1304C	20530	Arm Rotary Shaft Ball Bearing (intermediate) Case Set Screw.....
131482	20539	Arm Rotary Shaft Ball Bearing (intermediate) Collar with two 457C.....
457C	20539	Arm Rotary Shaft Ball Bearing (intermediate) Collar Set Screw.....
131457	20539	Arm Rotary Shaft Bushing (front).....
761E	20530	" " " " " Set Screw
42367	20530	" " " Front Bearing Oil Pad, lower (braided cotton).....
54218	20530	Arm Rotary Shaft Front Bearing Oil Pad, upper (braided cotton).....
144D	20530	Arm Rotary Shaft Screw.....
131276	20526	" Side Cover (oil vent).....
131277	20526	" " " Cap.....
131280	20530	" " " " Position Pin.....
51224W	20530	" " " " Thumb Screw.....
131278	-----	Arm Side Cover (oil vent) complete, Nos. 51224W, 131276, 131277 and 131280....
68448	20529	Arm Side Cover Gasket (cork).....
1057K	20530	" " " Screw.....
131483	20532	Balance Wheel, 2 in. pulley, with two 51283C.....
128510	20532	Balance Wheel Cover.....
51283C	20533	" " Set Screw.....
131374	20561	Cloth Plate.....
68368	20532	" " Slide (left).....
131050	20532	" " " " Spring.....
725J	20533	" " " " Screw....
131051	-----	Cloth Plate Slide (left) complete, Nos. 68368, 131050 and two 725J.....
131376	20599	Cloth Plate Slide (right) 1/16 in. Throat Plate clearance cut, for 131383.....
131381	20532	Cloth Plate Slide (right) Spring.....
725J	20533	" " " " Screw...
131383	-----	Cloth Plate Slide (right) complete (1/16 in. Throat Plate clearance cut) for 131389, Nos. 131376, 131381 and two 725J.....

No.	Plate	Name
131389	-----	Cloth Plate complete, for Throat Plates with 1/16 in. offset, Nos. 131051, 131374 and 131383.....
1011F	20533	Cloth Plate Screw (left).....
50396F	20533	" " " (right).....
131394	20561	" " Thread Guard.....
389F	20533	" " " " Screw (lower)...
50473F	20533	" " " " " (upper)...
*131471	20550	Crank Connecting Rod with two each 896C and 1057C.....
68459	-----	Crank Connecting Rod 131471 with 131072..
896C	20533	" " " Cap (lower) Screw...
1057C	20530	" " " " (upper) Screw...
68460	20532	Face Plate (lower half).....
68461	20532	" " " " Gasket (cork).....
330D	20533	" " " " Screw.....
131395	20532	" " (upper half).....
29234	20533	" " " " Position Plate....
1053E	20533	" " " " " Screw
51224W	20530	" " " " Thumb Screw.....
131396	20551	Feed Bar.....
131397	20551	Feed Bar complete, Nos. 50429C, 68467, 131396 and two 207E.....
131197	20551	Feed Bar Hinge Pin (eccentric).....
59343	20533	" " " " Collar with 735C.....
735C	20533	" " " " " Set Screw.....
134258	20533	" " Slide Block.....
134259	20533	" " " " 134258 with 68495 and 134260.....
68495	20533	Feed Bar Slide Block Oil Pad (wick).....
134260	20533	" " " " " Retainer....
68467	20551	" " Wearing Plate.....
207E	20533	" " " " Screw.....
131500	20551	" Connecting Rod with 1057C, 68497, 134260 and two 896C.....
131502	-----	Feed Connecting Rod 131500 with 54025....
896C	20533	" " " Cap Screw.....
1057C	20530	" " " Clamping Screw.....
58497	20533	" " " Oil Pad (wick).....
134260	20533	" " " " " Retainer.....
131551	20596	" Dog, 14 teeth (10 teeth to the inch) for 131558.....
157J	20533	Feed Dog Screw.....
50429C	20533	" " Stop Screw.....
*54024	-----	" Eccentric with 138306.....
*23729	-----	" " Body.....
51061C	20533	" " " Set Screw.....
7071	20533	" " Clamping Washer.....
217J	20533	" " " Screw.....
138306	20533	" " Lubricating Pad (wood)....

No.	Plate	Name
54025	20551	Feed Eccentric (adjustable) complete, Nos. 1103C, 23729, 54024 and two each 217J 7071 and 51061C.....
1103C	20533	Feed Regulating Screw.....
131240	20551	" Rocking Frame with two 453C.....
131398	-----	" " " 131240 with 59343, 131197 and 131397.....
57234	20551	Feed Rocking Frame Hinge Pin.....
57235	20533	" " " " " Bushing.....
453C	20600	" " " " " Set Screw.....
453C	20600	Feed Rocking Frame Hinge Pin Set Screw...
131552	20595	Looper (back) closed eye.....
452C	20600	" " Set Screw.....
131553	20595	" (front) closed eye.....
1120C	20600	" " Set Screw.....
54027	20595	" Carrier with two 175E.....
175E	20600	" " Adjusting Screw.....
54227	20595	" " Connection.....
54228	20594	" " " Shaft.....
128419	20546	" " " " Oil Pad (braided cotton).....
68478	20551	Looper Carrier Connection Shaft Sleeve (eccentric).....
51263D	20546	Looper Carrier Connection Shaft Sleeve Cap Screw.....
68479	20595	Looper Carrier Driver with four 175E....
175E	20600	" " " Cap Screw.....
*131110	20551	" Driving Shaft and Feed Lifting Eccentric with two 64315.....

Note: When No. 131110 is required for repairs, the Arm Rotary Shaft must be returned to the factory to be adjusted to the new part.

*131111	-----	Looper Driving Shaft and Feed Lifting Eccentric 131110 with 54027, 54227, 54228 and 68479.....
*68483	-----	Looper Driving Shaft and Feed Lifting Eccentric Bracket with 761E.....
948J	20546	Looper Driving Shaft and Feed Lifting Eccentric Bracket Screw.....
68484	20551	Looper Driving Shaft and Feed Lifting Eccentric Bushing.....
131028	20546	Looper Driving Shaft and Feed Lifting Eccentric Bushing Oil Plug.....
761E	20530	Looper Driving Shaft and Feed Lifting Eccentric Bushing Position Screw.....
68497	20533	Looper Driving Shaft and Feed Lifting Eccentric Front Bearing Oil Pad (wick).
64315	20546	Looper Driving Shaft and Feed Lifting Eccentric Oil Hole Plug.....

No.	Plate	Name
640E	20546	Looper Driving Shaft and Feed Lifting Eccentric Screw.....
131052	20595	Looper Holder with 452C and 1120C.....
51119J	20546	" " Screw.....
68485	20551	" Throw-out Handle with two 443C....
68486	20546	" " " Plunger.....
43503	20546	" " " Spring...
443C	20546	" " " Set Screw.....
64319	20566	Needle Bar (hollow).....
131554	-----	Needle Bar complete, Nos. 64319 and 131555
131291	20594	" " Bushing (lower).....
1133E	20600	" " " " Set Screw....
64320	20594	" " " (upper).....
1133E	20600	" " " " Set Screw....
68488	20595	" " Connecting Link and Thread (upper) Controller.....
131399	-----	Needle Bar Connecting Link and Thread (upper) Controller 68488 with 68489 and 131400.....
68489	20595	Needle Bar Connecting Link Hinge Stud (hollow).....
1520J	20566	Needle Bar Connecting Link Hinge Stud Nut
131270	20600	" " " " " " Oil Pad (wick).....
861C	20566	Needle Bar Connecting Link Hinge Stud Oil Plug Screw.....
853C	20600	Needle Bar Connecting Link Hinge Stud Set Screw.....
131400	20566	Needle Bar Connecting Stud with 211F and 1492E.....
1492E	20566	Needle Bar Connecting Stud Clamping Screw
131555	20594	" Clamp with two 50014F.....
131065	20594	" Guard (stationary).....
54038	20595	" " " Holder.....
176J	20566	" " " " Screw...
217C	20533	" " " " Screw.....
50014F	20600	" Set Screw.....
68492	20538	Oil Pipe (back of arm) with 49191 and 68497, for oiling Feed Rocking Frame Hinge Pin Front Bearing.....
68493	20538	Oil Pipe (back of arm) Clamp.....
176E	20566	" " " " " " Screw.....
68494	20538	" " " " " Connection with 49189, 68495 and two 198E, for oiling Feed Rocking Frame Hinge Pin Back Bearing.....
*49189	-----	Oil Pipe (back of arm) Connection Cap....
198E	20546	" " " " " " Screw
68495	20533	" " " " " Oil Pad (wick).....

No.	Plate	Name
68496	20538	Oil Pipe (back of arm) Coupling.....
1733	20546	" " " " " Nut (brass)
68497	20533	" " " " " Oil Pad (wick)....
*49191	-----	" " " " " Sleeve.....
68498	20538	" " (front of arm) with 131089 and two each 1733 and 49191, for oiling Looper Driving Shaft and Feed Lifting Eccentric Front Bearing.....
131112	20538	Oil Pipe (front of arm) with 68497 and 131003, for oiling Feed Bar Slide Block.....
68500	20538	Oil Pipe (front of arm) with 1733, 49191, 131084 and 131089, for oiling Arm Rotary Shaft Front Bearing.....
131113	20538	Oil Pipe (front of arm) with 68497 and 131003, for oiling Feed Connecting Rod.....
131258	-----	Oil Pipe (front of arm) complete, Nos. 68498, 68500, 131112 and 131113.....
131002	20538	Oil Pipe (front of arm) Connection with 131049 and two 198E, for oiling Looper Throw-out Device.....
131003	20538	Oil Pipe (front of arm) Connection with 49189 and two 198E, for 131112 and 131113.....
131084	20538	Oil Pipe (front of arm) Connection with 131085 and two 198E, for 68500.....
*49189	-----	Oil Pipe (front of arm) Connection Cap, for 131003.....
*131049	-----	Oil Pipe (front of arm) Connection Cap, for 131002.....
*131085	-----	Oil Pipe (front of arm) Connection Cap, for 131084.....
198E	20546	Oil Pipe (front of arm) Connection Cap Screw.....
131004	20538	Oil Pipe (front of arm) Coupling (center)
131004	20538	" " " " " " (left)..
*131086	-----	" " " " " " (right).
131087	20538	" " " " " " " "
*131088	-----	131086 with 131088.....
1733	20546	Oil Pipe (front of arm) Coupling (right) Oil Lead.....
131089	20546	Oil Pipe (front of arm) Coupling Nut (brass).....
68497	20533	Oil Pipe (front of arm) Oil Pad (wick) for 68498 and 68500.....
*49191	-----	Oil Pipe (front of arm) Oil Pad (wick) for 131112 and 131113.....
64330	20542	Oil Pipe (front of arm) Sleeve.....
		Presser Bar with 25303.....

No.	Plate	Name
25303	20546	Presser Bar Ball, size 1/4 in.....
131006	20565	" " Bushing (lower).....
1133E	20600	" " " " Set Screw....
38456	20565	" " " (upper).....
1133E	20600	" " " " Set Screw....
131401	20565	" " Lifting Bracket with 453C....
11173	20565	" " " " Guide.....
453C	20600	" " " " " Set Screw
453C	20600	" " " " " Set Screw....
131402	20542	" " " Lever.....
68184	20542	" " " " Extension.....
161J	20546	" " " " " Screw..
802D	20546	" " " " Hinge Screw....
38467	20542	" " Spring (flat).....
*131231	-----	" " " (auxiliary).....
*131232	-----	" " " " Guide.....
4604	20600	" " " " " Rivet
131198	20561	Presser Bar Spring (auxiliary) complete, Nos. 4604, 131231 and 131232.....
38468	20565	Presser Bar Spring Stud.....
26276	20565	" Foot Hinge Pin.....
131556	-----	" " Plate.....
46099	-----	" " Shank.....
131557	20596	Presser Foot (hinged) complete, Nos.26276 46099 and 131556.....
190J	20530	Presser Foot Screw.....
574W	20600	Pressure Regulating Thumb Screw.....
1539W	20600	" " " " Lock Nut..
131025	20566	Slack Thread Controller.....
54242	20594	" " " Clamp.....
190J	20530	" " " Screw.....
131403	20565	" " Regulator.....
131404	20565	" " " Holder.....
131405	20565	" " " Crank with 171E.....
1423J	20566	Slack Thread Regulator Holder Crank Cap Screw.....
171E	20565	Slack Thread Regulator Holder Crank Clamping Screw.....
131406	20565	Slack Thread Regulator Holder Crank Con- necting Link.....
217J	20533	Slack Thread Regulator Screw.....
131012	20542	Tension (under thread) Bracket.....
691F	20566	" " " " Screw.....
2102	20565	" " " Disc.....
51570C	20565	" " " Regulating Thumb Nut.....
50326C	20565	Tension (under thread) Screw Stud.....
59539	-----	" " " " 50326C with 51570C.....

No.	Plate	Name
59534	20565	Tension (under thread) Spring.....
59537	20565	" " " " Bushing (large).....
59538	20565	Tension (under thread) Spring Bushing (small).....
57076	20565	Tension (under thread) Thread Guide.....
54070	20566	" (upper thread) Bracket.....
376J	20565	" " " " Screw.....
2102	20565	" " " Disc.....
51570C	20565	" " " Regulating Thumb Nut.....
32572	20600	Tension (upper thread) Releasing Disc....
54988	20565	" " " " Pin.....
54071	20594	" " " " Shaft...
54047	20539	" " " " "
54048	20539	Crank with 624C.....
624C	20539	Tension (upper thread) Releasing Shaft Crank Link.....
68261	20539	Tension (upper thread) Releasing Shaft Crank Set Screw.....
131011	20539	Tension (upper thread) Releasing Shaft Spring.....
316C	20539	Tension (upper thread) Releasing Shaft Spring Position Plate.....
1547J	20539	Tension (upper thread) Releasing Shaft Stop Screw.....
50326C	20565	Tension (upper thread) Releasing Shaft Stop Screw Nut.....
59539	-----	Tension (upper thread) Screw Stud..... " " " " " 50326C with 51570C.....
59535	20600	Tension (upper thread) Spring.....
59537	20565	" " " " Bushing (large).....
59538	20565	Tension (upper thread) Spring Bushing (small).....
57076	20565	Tension (upper thread) Thread Guide (double).....
53225	20539	Thread (under) Eyelet (back).....
190J	20530	" " " " Screw.....
131407	20539	" " Take-up with 1258C.....
131408	20594	" " " Oil Guard.....
50438J	20566	" " " " Screw...
1258C	20539	" " " Set Screw.....
131409	20594	" " " Stripper.....
54242	20594	" " " Clamp....
190J	20530	" " " " Screw
131410	20542	" " " " Plate....
131411	20542	" " " " "
		Bracket.....

No.	Plate	Name
131412	-----	Thread (under) Take-up Stripper Plate Bracket 131411 with 32062, 50438J 54242, 131408 to 131410, 131413 to 131415, two each 207J, 7071, 50470J and four 190J.....
965D	20600	Thread (under) Take-up Stripper Plate Bracket Screw.....
190J	20530	Thread (under) Take-up Stripper Plate Screw.....
32062	20594	Thread (under) Take-up Stripper Washer...
131413	20594	" " " Thread Guard (fibre)
50470J	20566	" " " " " Screw..
131414	20594	" " " " Guide (left).
207J	20533	" " " " " " Screw.....
7071	20533	Thread (under) Take-up Thread Guide(left) Screw Washer.....
131415	20594	Thread (under) Take-up Thread Guide (right).....
207J	20533	Thread (under) Take-up Thread Guide (right) Screw.....
7071	20533	Thread (under) Take-up Thread Guide (right) Screw Washer.....
46009	20566	Thread (upper) Eyelet.....
190J	20530	" " " Screw.....
131334	20566	" " Take-up.....
54095	20566	" " Plate.....
68164	20565	" " " Spring.....
1449J	20566	" " " " Screw.
131335	-----	Thread (upper) Take-up complete, Nos. 1449J, 54095, 68164 and 131334.....
211F	20566	Thread (upper) Take-up Set Screw.....
131558	20596	Throat Plate for 131551.....
742F	20600	" " Screw.....
*15404	-----	Trade Mark.....
15405	-----	" " Rivet.....

MACHINE No. 147-105

For Seat Seaming Medium and Medium-Heavy Trousers. Two needles, two loopers. Needles set tandem 3/16 inch apart. Ball bearing. Needle bar stroke 1 5/16 inches. The loopers are arranged so that they may be thrown out of position for convenience in threading. An improved oiling system automatically oils all of the principal bearings of the machine. Speed 4000 R. P. M.

NOTE: THIS MACHINE IS THE SAME AS THE 147-104 MACHINE WITH THE FOLLOWING EXCEPTIONS:

No.	Plate	Name
131486	20594	Arm Rock Shaft Crank, back (ball bearing, solid) with two 50083C, in place of 131072.....
131487	20561	Arm Rotary Shaft in place of 131476.....
131488	-----	" " " 131487 with 640E, 131111 131489 and 131502, in place of 131485
131379	20599	Cloth Plate Slide (right) 9/64 in. Throat Plate clearance cut, for 131386.....
131386	-----	Cloth Plate Slide (right) complete (9/64 in. Throat Plate clearance cut) for 131392, Nos. 131379, 131381 and two 725J, in place of 131383.....
131392	-----	Cloth Plate complete, for Throat Plates with 9/64 in. offset, Nos. 131051, 131374 and 131386, in place of 131389
131489	-----	Crank Connecting Rod 131471 with 131486, in place of 68459.....
131559	20596	Feed Dog, 12 teeth (8 teeth to the inch) for 131562, in place of 131551.....
26278	20565	Presser Foot Hinge Pin.....
131560	-----	" " Plate.....
131513	-----	" " Shank.....
131561	20596	Presser Foot (hinged) complete, Nos. 26276 131513 and 131560, in place of 131557
131562	20596	Throat Plate for 131559, in place of 131558.....

MACHINE No. 147-106

For Seat Seaming Light and Medium Trousers. Two needles, two loopers. Gauge 1/32 inch. Ball bearing. Needle bar stroke 1 7/32 inches. The loopers are arranged so that they may be thrown out of position for convenience in threading. An improved oiling system automatically oils all of the principal bearings of the machine. Speed 4000 R. P. M.

NOTE: THIS MACHINE IS THE SAME AS THE 147-104 MACHINE
WITH THE FOLLOWING EXCEPTIONS:

No.	Plate	Name
131563	20595	Looper (back) closed eye, in place of 131552.....
131564	20595	Looper (front) closed eye, in place of 131553.....
131063	-----	Needle Bar complete, for 1/32 in. gauge, Nos. 64319 and 131064, in place of 131554.....
131064	20594	Needle Clamp with two 50014F, for 1/32 in. gauge, in place of 131555.....
68140	20600	Presser Foot Hinge Pin.....
665J	20600	" " " " Set Screw.....
131349	-----	" " Knife.....
239J	20600	Presser Foot Knife Screw.....
131568	-----	" " Plate.....
131569	-----	" " Shank with 665J.....
131570	20597	Presser Foot (hinged) with Knife complete for 1/32 in. gauge, Nos. 239J, 68140, 131349, 131568 and 131569.....
Note: No. 131570 is regularly furnished on machine.		
26276	20565	Presser Foot Hinge Pin.....
131565	-----	" " Plate.....
46099	-----	" " Shank.....
131566	20597	Presser Foot (hinged) complete, for 1/32 in. gauge, Nos. 26276, 46099 and 131565.....
131567	20597	Throat Plate, for 131551.....

MACHINE No. 147-107

For Seat Seaming Medium and Medium-Heavy Trousers. Two needles, two loopers. Gauge 1/32 inch. Ball bearing. Needle bar stroke 1 5/16 inches. The loopers are arranged so that they may be thrown out of position for convenience in threading. An improved oiling system automatically oils all of the principal bearings of the machine. Speed 4000 R. P. M.

NOTE: THIS MACHINE IS THE SAME AS THE 147-104 MACHINE
WITH THE FOLLOWING EXCEPTIONS:

No.	Plate	Name
131486	20594	Arm Rock Shaft Crank, back (ball bearing, solid) with two 50083C, in place of 131072.....
131487	20561	Arm Rotary Shaft in place of 131476.....
131488	-----	" " " " 131487 with 640E, 131111 131489 and 131502, in place of 131479
131379	20599	Cloth Plate Slide (right) 9/64 in. Throat Plate clearance cut, for 131386.....
131386	-----	Cloth Plate Slide (right) complete (9/64 in. Throat Plate clearance cut, for 131392, Nos. 131379, 131381 and two 725C, in place of 131383.....
131392	-----	Cloth Plate complete, for Throat Plates with 9/64 in. offset, Nos. 131051, 131374 and 131386, in place of 131389
131489	-----	Crank Connecting Rod 131471 with 131486, in place of 68459.....
131060	20598	Feed Dog, 16 teeth (10 teeth to the inch) for 1/32 in. gauge, for 131071, in place of 131551.....
131563	20595	Looper (back) closed eye, in place of 131552.....
131564	20595	Looper (front) closed eye, in place of 131553.....
131063	-----	Needle Bar complete, for 1/32 in. gauge, Nos. 64319 and 131064, in place of 131554.....
131064	20594	Needle Clamp with two 50014F, for 1/32 in. gauge, in place of 131555.....
131356	-----	Presser Foot Chaining-off Plate.....
20178	-----	" " " " Spring...

No.	Plate	Name
1296C	-----	" " " " Stop Screw
26276	20565	" " Hinge Pin.....
131571	-----	" " Knife.....
220J	-----	" " Screw.....
131572	-----	" " Plate.....
131359	-----	" " Shank.....
131573	20598	Presser Foot (hinged) with Chaining-off Plate and Knife complete, for 1/32 in. gauge, Nos. 1296C, 20178, 26276, 131356, 131359, 131571, 131572 and two 220J.....
131071	20598	Throat Plate, for 1/32 in. gauge, for 131060, in place of 131558.....

MACHINE No. 147-108

For Seat Seaming Medium Heavy and Heavy Trousers. Two needles, two loopers. Needles set tandem 3/16 inch apart. Ball bearing. Needle bar stroke 1 3/8 inches. The loopers are arranged so that they may be thrown out of position for convenience in threading. An improved oiling system automatically oils all of the principal bearings of the machine. Speed 3800 R. P. M.

NOTE: THIS MACHINE IS THE SAME AS THE 147-104 MACHINE WITH THE FOLLOWING EXCEPTIONS:

No.	Plate	Name
131487	20561	Arm Rotary Shaft in place of 131476.....
131510	-----	" " " 131487 with 640E, 68459, 131111 and 131502, in place of 131485
131379	20599	Cloth Plate Slide (right) 9/64 in. Throat Plate clearance cut, for 131386, in place of 131376.....
131386	-----	Cloth Plate Slide (right) complete (9/64 in. Throat Plate clearance cut) for 131392, Nos. 131379, 131381 and two 725J, in place of 131383.....
131392	-----	Cloth Plate complete, for Throat Plates with 9/64 in. offset, Nos. 131051, 131374 and 131386, in place of 131389
131559	20596	Feed Dog, 12 teeth (8 teeth to the inch) for 131562, in place of 131551.....
131292	20594	Presser Bar Bushing (lower) in place of 131006.....
26276	20565	Presser Foot Hinge Pin.....
131560	-----	" " Plate.....
131513	-----	" " Shank.....
131561	20596	Presser Foot (hinged) complete, Nos. 26276 131513 and 131560, in place of 131557
131562	20596	Throat Plate for 131559, in place of 131558.....

ACCESSORIES

No.	Plate	Name
120344	20545	Oiler (copper plated) with 120345.....
120345	20545	" Spout, 4-1/2 in. long.....
120440	20545	Screw Driver (large).....
121108	20545	" " (small).....
120341	20545	Tweezers (curved).....
4822	20545	Wrench for 1547.....
8908	20545	" " 1520.....

BELT GUARD

No.	Plate	Name
68222	20549	Belt Guard with two wood screws 1 in.No. 12.....

BENCH STAND

No.	Plate	Name
79772	-----	Bench Stand with 27998, two each 41538, 126849, three wood screws 1-1/4 in. No. 12, four each 60656, wood screws 1-1/4 in. No. 10 and sixteen wood screws 5/8 in. No. 7.....
126849	9520	Flap Hinge with four wood screws 3/4 in. No. 7.....
27998	9520	Flap Hook and Eye (brass) with wood screw 1/2 in. No. 5.....
126247	9520	Flush Bolt.....
126248	9520	" " Plate.....
41538	-----	Flush Bolt with Plate complete, Nos. 126247 126248 and four brass wood screws 5/8 in. No. 4.....
60656	9520	Hinge.....

FOOT LIFTER PARTS

No.	Plate	Name
6439	-----	Chain, 36 in. to 45 in., with 56864 and 56865.....
Note: When ordering No. 6439, state length required.		
4879	20545	Chain Connecting Link.....
56864	20545	" Hook (large).....

No.	Plate	Name
56865	20545	Chain Hook (small).....
126249	20549	Treadle.....
4882	20547	" Shaft.....
126250	20547	" Spring.....
150451	20549	" Stand.....
150452	20549	Treadle complete, Nos. 4879, 4882, 126249 126250, 150451 and two wood screws 1 in. No. 16.....

KNEE LIFTER PARTS

No.	Plate	Name
37563	-----	Chain, length 15 in., with 56864 and 56865
56864	20545	" Hook (large).....
56865	20545	" " (small).....
2763	20561	Rock Shaft.....
12242	20561	" " Hanger with two wood screws 1 in. No. 10.....
6335	20561	Rock Shaft Knee Arm.....
6336	-----	Rock Shaft Knee Arm complete, Nos. 2766, 2767 and 6335.....
2766	20561	Rock Shaft Knee Arm Hub with 356C.....
356C	20546	" " " " " Set Screw.....
2767	20561	" " " Plate with 356C.....
356C	20546	" " " " " Set Screw.....
6337	20561	" " Lifting Bracket with two 356C.
7125	20561	" " " " " Hook.....
356C	20546	" " " " " Set Screw.
356C	20546	" " " " " Set Screw.....
2770	20561	" " Stop Dog with 356C.....
356C	20546	" " " " " Set Screw.....
23767	20561	Rock Shaft complete, Nos. 2763, 2770, 6336 6337, 7125 and two 12242.....

MACHINE BASE

No.	Plate	Name
131263	20549	Machine Base.....
54477	20547	" " Screw Stud, to fasten base to table.....
131205	20547	Machine Base Screw Stud, to position machine on base.....
51576E	20547	Machine Base Screw Stud Nut.....
9842	20547	" " " " " Washer.....
131022	20547	" " " " " Bushing (rubber).

No.	Plate	Name
131279	20547	Machine Cushion (felt).....
131264	-----	Machine Base complete, Nos. 131263, three each 9842, 51576E, 54477 and four each 131205 and 131279.....
131328	-----	Machine Base and Oil Drain Jar (swinging type) complete, Nos. 131264 and 131268

MACHINE BASE OIL DRAIN JAR (SWINGING TYPE)

No.	Plate	Name
131185	20526	Jar (glass).....
131191	20526	" Cap.....
131188	20526	" Clamp.....
131217	-----	" " 131188 with 131189.....
131189	20526	" " Lever.....
1247C	20546	" " " Hinge Screw.....
131265	20526	Nipple (long).....
131266	20526	" (short).....
131267	20526	" Elbow.....
131268	-----	Machine Base Oil Drain Jar (swinging type) complete, Nos. 131185, 131191, 131217 131266 and two each 1247C, 131265 and 131267.....

THREAD UNWINDER (FOR FOUR SPOOLS)

No.	Plate	Name
225257	9505	Spool Rest (for two spools) with 201018C.
150203	9505	" " Cushion (felt).....
225388	9505	" " Rod.....
200383C	20546	" " " Set Screw.....
201018C	20546	" " Set Screw.....
202490	9505	" Stand with 200383C.....
225391	9505	Thread Guide.....
201696J	20546	" " Lock Nut.....
225326	20546	" " Position Cup.....
225324	9505	" " Rod with 208E and 225322....
208E	20546	" " " Screw.....
225322	20546	" " " Washer.....
*150057	-----	" Separator.....
150058	9505	" " 150057 with 150059.....

No.	Plate	Name
*150059	-----	Thread Separator Bracket.....
150060	9505	" " " Arm with 164J and 9525.....
164J	20546	Thread Separator Bracket Arm Clamping Screw.....
9525	20546	Thread Separator Bracket Arm Clamping Screw Washer.....
164J	20546	Thread Separator Bracket Arm Screw.....
9525	20546	" " " " " Washer.
150061	-----	Thread Separator complete, Nos. 164J, 9525 150058 and 150060.....
150062	9505	Thread Unwinder complete, Nos. 150061, 201696J, 202490, 225324, 225326, 225388, two 225257, three wood screws 7/8 in. No. 12 and four each 150203 and 225391.....
27739	20561	Thread Cone (wood) for large cones.....
225390	20561	" " Holder, for inverted cones...

Note: Nos. 27739 and 225390 are used with, but not included in 150062.

SINGER Needles should be used
in SINGER Machines
These Needles and their Containers
are marked with the
Company's Trade Mark "SIMANCO.**" 1

Needles in Containers marked
"FOR SINGER MACHINES"
are NOT SINGER made needles. 2

NUMERICAL LIST OF PARTS

No.	Plate	Name
144D	20530	Arm Rotary Shaft Screw.....
157J	20533	Feed Dog Screw.....
161J	20546	Presser Bar Lifting Lever Extension Screw
164J	20546	Thread Unwinder Thread Separator Bracket Arm Clamping Screw, for 150060.....
164J	20546	Thread Unwinder Thread Separator Bracket Arm Screw, for 150061.....
171E	20565	Slack Thread Regulator Holder Crank Clamping Screw, for 131405.....
175E	20600	Looper Carrier Adjusting Screw, for 54027.
175E	20600	" " Driver Cap Screw, for 68479
176E	20566	Oil Pipe (back of arm) Clamp Screw.....
176J	20566	Needle Guard (stationary) Holder Screw...
190J	20530	Presser Foot Screw.....
190J	20530	Slack Thread Controller Clamp Screw.....
190J	20530	Thread (under) Eyelet (back) Screw.....
190J	20530	" " Take-up Stripper Clamp Screw, for 131412.....
190J	20530	Thread (under) Take-up Stripper Plate Screw, for 131412.....
190J	20530	Thread (upper) Eyelet Screw.....
198E	20546	Oil Pipe (back of arm) Connection Cap Screw, for 68494.....
198E	20546	Oil Pipe (front of arm) Connection Cap Screw, for 131002, 131003 and 131084..
205C	20530	Arm Rotary Shaft Ball Bearing (back) Case Cap Screw, for 131479.....
207E	20533	Feed Bar Wearing Plate Screw, for 131397.
207J	20533	Thread (under) Take-up Thread Guide (left) Screw, for 131412.....
207J	20533	Thread (under) Take-up Thread Guide (right) Screw, for 131412.....
208E	20546	Thread Unwinder Thread Guide Rod Screw, for 225324.....
211F	20566	Thread (upper) Take-up Set Screw, for 131400.....
217J	20533	Feed Eccentric Clamping Washer Screw, for 54025.....
217C	20533	Needle Guard (stationary) Screw.....
217J	20533	Slack Thread Regulator Screw.....
220J	20600	Presser Foot Knife Screw, for 131573.....
239J	20600	" " " " " 131570.....
316C	20539	Tension (upper thread) Releasing Shaft Stop Screw.....
330D	20533	Face Plate (lower half) Screw.....

SINGER Needles should be used
in SINGER Machines
These Needles and their Containers
are marked with the
Company's Trade Mark "SIMANCO.**" 1

Needles in Containers marked
"FOR SINGER MACHINES"
are NOT SINGER made needles. 2

No.	Plate	Name
356C	20546	Rock Shaft Knee Arm Hub Set Screw, for 2766.....
356C	20546	Rock Shaft Knee Plate Set Screw, for 2767
356C	20546	" " Lifting Bracket Hook Set Screw for 6337.....
356C	20546	Rock Shaft Lifting Bracket Set Screw, for 6337.....
356C	20546	Rock Shaft Stop Dog Set Screw, for 2770..
376J	20565	Tension (upper thread) Bracket Screw.....
389F	20533	Cloth Plate Thread Guard Screw (lower)...
423C	20530	Arm Rock Shaft Bushing (intermediate) Set Screw.....
429C	20530	Arm Rotary Shaft Ball Bearing (back) Case Set Screw.....
443C	20546	Looper Throw-out Handle Set Screw, for 68485.....
446C	20530	Arm Rock Shaft Bushing (back) Set Screw..
452C	20600	Looper (back) Set Screw, for 131052.....
453C	20600	Arm Rock Shaft Flanged Bushing (front) Set Screw.....
453C	20600	Feed Rocking Frame Hinge Pin Bushing Set Screw, for 131240.....
453C	20600	Feed Rocking Frame Hinge Pin Set Screw...
453C	20600	Presser Bar Lifting Bracket Guide Set Screw.....
453C	20600	Presser Bar Lifting Bracket Set Screw, for 131401.....
457C	20539	Arm Rotary Shaft Ball Bearing (intermediate) Collar Set Screw, for 131482....
563C	20530	Arm Oil Cup Drip Pan Position Screw, for 131305.....
574W	20600	Pressure Regulating Thumb Screw.....
624C	20539	Tension (upper thread) Releasing Shaft Crank Set Screw, for 54047.....
640E	20546	Looper Driving Shaft and Feed Lifting Eccentric Screw, for 131435, 131488 and 131510.....
665J	20600	Presser Foot Hinge Pin Set Screw, for 131569.....
691F	20566	Tension (under thread) Bracket Screw.....
725J	20533	Cloth Plate Slide (left) Spring Screw, for 131051.....
725J	20533	Cloth Plate Slide (right) Spring Screw, for 131363 and 131366.....
735C	20533	Feed Bar Hinge Pin Collar Set Screw, for 59343.....
742F	20600	Throat Plate Screw.....
761E	20530	Arm Rotary Shaft Bushing (front) Set Screw.....

No.	Plate	Name
761E	20530	Looper Driving Shaft and Feed Lifting Eccentric Bushing Position Screw, for 68483.....
802D	20546	Presser Bar Lifting Lever Hinge Screw....
853C	20600	Needle Bar Connecting Link Hinge Stud Set Screw, for 131475.....
861C	20566	Needle Bar Connecting Link Hinge Stud Oil Plug Screw.....
896C	20533	Crank Connecting Rod Cap (lower) Screw, for 131471.....
896C	20533	Feed Connecting Rod Cap Screw, for 131500
948J	20546	Looper Driving Shaft and Feed Lifting Eccentric Bracket Screw, for 131446....
965D	20600	Thread (under) Take-up Stripper Plate Bracket Screw.....
1011F	20533	Cloth Plate Screw (left).....
1053E	20533	Face Plate (upper half) Position Plate Screw.....
1057C	20530	Arm Bottom Cover Screw.....
1057K	20530	" Side Cover Screw.....
1057C	20530	Crank Connecting Rod Cap (upper) Screw for 131471.....
1057C	20530	Feed Connecting Rod Clamping Screw, for 131500.....
1103C	20533	Feed Regulating Screw, for 54025.....
1120C	20600	Looper (front) Set Screw, for 131052.....
1133E	20600	Needle Bar Bushing (lower) Set Screw....
1133E	20600	" " " (upper) Set Screw.....
1133E	20600	Presser Bar Bushing (lower) Set Screw....
1133E	20600	" " " (upper) Set Screw....
1235F	20530	Arm Rock Shaft Oil Plug Screw, for 131474
1247C	20546	Machine Base Oil Drain Jar Clamp Lever Hinge Screw, for 131268.....
1258C	20539	Thread (under) Take-up Set Screw, for 131407.....
1296C	20600	Presser Foot Chaining-off Plate Stop Screw, for 131573.....
1304C	20530	Arm Rotary Shaft Ball Bearing (intermediate) Case Set Screw.....
1309C	20530	Arm Rock Shaft Adjusting Screw.....
1423J	20566	Slack Thread Regulator Holder Crank Cap Screw.....
1449J	20566	Thread (upper) Take-up Plate Spring Screw for 131335.....
1492E	20566	Needle Bar Connecting Stud Clamping Screw for 131400.....
1520J	20566	Needle Bar Connecting Link Hinge Stud Nut
1539W	20600	Pressure Regulating Thumb Screw Lock Nut.
1547J	20539	Tension (upper thread) Releasing Shaft Stop Screw Nut.....

NUMERICAL LIST OF PARTS

No.	Plate	Name
1733	20546	Oil Pipe (back of arm) Coupling Nut (brass).....
1733	20546	Oil Pipe (front of arm) Coupling Nut (brass) for 68498 and 68500.....
2102	20565	Tension (under thread) Disc.....
2102	20565	" (upper thread) Disc.....
2763	20561	Rock Shaft, for 23767.....
2766	20561	" " Knee Arm Hub with 356C, for 6336.....
2767	20561	Rock Shaft Knee Plate with 356C, for 6336
2770	20561	" " Stop Dog with 356C, for 23767.
4604	20600	Presser Bar Spring (auxiliary) Guide Rivet, for 131198.....
4822	20545	Wrench for 1547 (Accessories).....
4879	20545	Chain Connecting Link, for 150452.....
4882	20547	Treadle Shaft, for 150452.....
6335	20561	Rock Shaft Knee Arm, for 6336.....
6336	-----	Rock Shaft Knee Arm complete for 23767, Nos. 2766, 2767 and 6335.....
6337	20561	Rock Shaft Lifting Bracket with two 356C, for 23767.....
6439	-----	Chain, 36 in. to 45 in. with 56864 and 56865.....
7071	20533	Feed Eccentric Clamping Washer, for 54025.
7071	20533	Thread (under) Take-up Thread Guide(left) Screw Washer, for 131412.....
7071	20533	Thread (under) Take-up Thread Guide (right) Screw Washer, for 131412.....
7125	20561	Rock Shaft Lifting Bracket Hook, for 23767
8908	20545	Wrench for 1520 (Accessories).....
9525	20546	Thread Unwinder Thread Separator Bracket Arm Clamping Screw Washer, for 150060
9525	20546	Thread Unwinder Thread Separator Bracket Arm Screw Washer, for 150061.....
9842	20547	Machine Base Screw Stud Nut Washer, for 131264.....
11173	20565	Presser Bar Lifting Bracket Guide.....
12242	20561	Rock Shaft Hanger with two wood screws, 1 in. No. 10, for 23767.....
*15404	-----	Trade Mark, for 131446.....
15405	-----	" " Rivet, for 131446.....
20178	-----	Presser Foot Chaining-off Plate Spring, for 131573.....
*23729	-----	Feed Eccentric Body, for 54025.....
23767	20561	Rock Shaft complete, Nos. 2763, 2770, 6336, 6337, 7125 and two 12242.....
25303	20546	Presser Bar Ball, size 1/4 in., for 64330
26276	20565	" Foot Hinge Pin, for 131557, 131561, 131566 and 131573.....

NUMERICAL LIST OF PARTS

No.	Plate	Name
27739	20561	Thread Unwinder Thread Cone (wood) for large cones.....
27998	9520	Bench Stand Flap Hook and Eye (brass) with wood screws 1/2 in. No. 5, for 79772.....
29234	20533	Face Plate (upper half) Position Plate...
32062	20594	Thread (under) Take-up Stripper Washer, for 131412.....
32572	20600	Tension (upper thread) Releasing Disc....
37563	-----	Chain, length 15 in., with 56864 and 56865
38456	20565	Presser Bar Bushing (upper).....
38467	20542	" " Spring (flat).....
38468	20565	" " Stud.....
41538	-----	Bench Stand Flush Bolt with Plate complete for 79772, Nos. 126247, 126248 and four brass wood screws 5/8 in. No. 4.....
42365	20530	Arm Rock Shaft Oil Pad (braided cotton) for oiling Back Bearing.....
42367	20530	Arm Rotary Shaft Front Bearing Oil Pad lower (braided cotton).....
43503	20546	Looper Throw-out Handle Plunger Spring...
46009	20566	Thread (upper) Eyelet.....
46099	-----	Presser Foot Shank, for 131557 and 131566
*49189	-----	Oil Pipe (back of arm) Connection Cap, for 68494.....
*49189	-----	Oil Pipe (front of arm) Connection Cap, for 131003.....
*49191	-----	Oil Pipe (back of arm) Sleeve, for 68492.
*49191	-----	" " (front of arm) Sleeve, for 68498 and 68500.....
50014F	20600	Needle Set Screw, for 131064 and 131555..
50083C	20530	Arm Rock Shaft Crank (back) Set Screw, for 131072 and 131486.....
50326C	20565	Tension (under thread) Screw Stud, for 59539.....
50326C	20565	Tension (upper thread) Screw Stud, for 59539.....
50396F	20533	Cloth Plate Screw (right).....
50429C	20533	Feed Dog Stop Screw, for 131397.....
50438J	20566	Thread (under) Take-up Oil Guard Screw, for 131412.....
50470J	20566	Thread (under) Take-up Thread Guard Screw for 131412.....
50473F	20533	Cloth Plate Thread Guard Screw (upper)...
50608R	20530	Arm Hole Plug Screw, for access to Crank Connecting Rod (upper bearing).....
51061C	20533	Feed Eccentric Body Set Screw, for 54025.
51119J	20546	Looper Holder Screw.....

No.	Plate	Name
51224W	20530	Arm Side Cover Cap Thumb Screw, for 131278
51224W	20530	Face Plate (upper half) Thumb Screw.....
51263D	20546	Looper Carrier Connection Shaft Sleeve Cap Screw.....
51283C	20533	Balance Wheel Set Screw, for 131483.....
51570C	20565	Tension (under thread) Regulating Thumb Nut, for 59539.....
51570C	20565	Tension (upper thread) Regulating Thumb Nut, for 59539.....
51576E	20547	Machine Base Screw Stud Nut, for 131264..
53225	20539	Thread (under) Eyelet (back).....
*54024	-----	Feed Eccentric with 138306, for 54025....
54025	20551	Feed Eccentric (adjustable) complete for 131502, Nos. 1103C, 23729, 54024 and two each 217J, 7071 and 51061C.....
54027	20595	Looper Carrier with two 175E, for 131111.
54038	20595	Needle Guard (stationary) Holder.....
54047	20539	Tension (upper thread) Releasing Shaft Crank with 624C.....
54048	20539	Tension (upper thread) Releasing Shaft Crank Link.....
54070	20566	Tension (upper thread) Bracket.....
54071	20594	" " " Releasing Shaft...
54095	20566	Thread (upper) Take-up Plate, for 131335.
54218	20530	Arm Rotary Shaft Front Bearing Oil Pad, upper (braided cotton).....
54227	20595	Looper Carrier Connection, for 131111....
54228	20594	" " " Shaft, for 131111
54242	20594	Slack Thread Controller Clamp.....
54242	20594	Thread (under) Take-up Stripper Clamp, for 131412.....
54477	20547	Machine Base Screw Stud, to fasten base to table, for 131264.....
54969	20530	Arm Rock Shaft Oil Pad (braided cotton) for oiling Intermediate Bearing.....
54988	20565	Tension (upper thread) Releasing Pin....
56664	20545	Chain Hook (large) for 6439 and 37563....
56865	20545	" " (small) for 6439 and 37563....
57076	20565	Tension (under thread) Thread Guide.....
57076	20565	" (upper thread) Thread Guide (double).....
57234	20551	Feed Rocking Frame Hinge Pin.....
57235	20533	" " " " Bushing....
59343	20533	" Bar Hinge Pin Collar with 735C, for 131398.....
59534	20565	Tension (under thread) Spring.....
59535	20600	" (upper thread) Spring.....
59537	20565	" (under thread) Spring Bushing (large).....

No.	Plate	Name
59537	20565	Tension (upper thread) Spring Bushing (large).....
59538	20565	Tension (under thread) Spring Bushing (small).....
59538	20565	Tension (upper thread) Spring Bushing (small).....
59539	-----	Tension (under thread) Screw Stud 50326C with 51570C.....
59539	-----	Tension (upper thread) Screw Stud 50326C with 51570C.....
60656	9520	Bench Stand Hinge, for 79772.....
64315	20546	Looper Driving Shaft and Feed Lifting Ec- centric Oil Hole Plug, for 131110....
64319	20566	Needle Bar (hollow) for 131063 and 131554
64320	20594	" " Bushing (upper).....
64330	20542	Presser Bar with 25303.....
68140	20600	" Foot Hinge Pin, for 131570.....
68164	20565	Thread (upper) Take-up Plate Spring, for 131335.....
68184	20542	Presser Bar Lifting Lever Extension.....
68222	20549	Belt Guard with two wood screws 1 in. No. 12.....
68261	20539	Tension (upper thread) Releasing Shaft Spring.....
68350	20530	Arm Oil Cup, for oiling Arm Rock Shaft Front Bearing.....
68368	20532	Cloth Plate Slide (left) for 131051.....
68428	20529	Arm Bottom Cover.....
68429	20529	" " " Gasket (cork).....
*68430	-----	" Oil Cup, for 131309.....
68433	20550	" Rock Shaft Bushing (back).....
68435	20550	" " " " Cap.....
68436	20550	" " " " (Intermediate)....
68448	20529	" Side Cover Gasket (cork).....
68459	-----	Crank Connecting Rod 131471 with 131072, for 131485 and 131510.....
68460	20532	Face Plate (lower half).....
68461	20532	" " " " Gasket (cork)....
68467	20551	Feed Bar Wearing Plate, for 131397.....
68478	20551	Looper Carrier Connection Shaft Sleeve (eccentric).....
68479	20595	Looper Carrier Driver with four 175E, for 131111.....
*68483	-----	Looper Driving Shaft and Feed Lifting Ec- centric Bracket with 761E, for 131446
68484	20551	Looper Driving Shaft and Feed Lifting Ec- centric Bushing.....
68485	20551	Looper Throw-out Handle with two 443C....
68486	20546	" " " Plunger.....

No.	Plate	Name
68488	20595	Needle Bar Connecting Link and Thread (upper) Controller, for 131399.....
68489	20595	Needle Bar Connecting Link Hinge Stud (hollow) for 131399.....
68492	20538	Oil Pipe (back of arm) with 49191 and 68497, for oiling Feed Rocking Frame Hinge Pin Front Bearing.....
68493	20538	Oil Pipe (back of arm) Clamp.....
68494	20538	" " " " " Connection with 49189, 68495 and two 198E, for oiling Feed Rocking Frame Hinge Pin Back Bearing.....
68495	20533	Feed Bar Slide Block Oil Pad (wick) for 134259.....
68495	20533	Oil Pipe (back of arm) Connection Oil Pad (wick) for 68494.....
68496	20538	Oil Pipe (back of arm) Coupling.....
68497	20533	Feed Connecting Rod Oil Pad (wick) for 131500.....
68497	20533	Looper Driving Shaft and Feed Lifting Eccentric Front Bearing Oil Pad (wick).
68497	20533	Oil Pipe (back of arm) Oil Pad (wick) for 68492.....
68497	20533	Oil Pipe (front of arm) Oil Pad (wick) for 131112 and 131113.....
68498	20538	Oil Pipe (front of arm) with 131089 and two each 1733 and 49191, for oiling Looper Driving Shaft and Feed Lifting Eccentric Front Bearing, for 131258..
68500	20538	Oil Pipe (front of arm) with 1733, 49191, 131084 and 131089, for oiling Arm Rotary Shaft Front Bearing, for 131258
79772	-----	Bench Stand with 27998, two each 41538, 126849, three wood screws 1-1/4 in. No. 12, four each 60656, wood screws 1-1/4 in. No. 10 and sixteen wood screws 5/8 in. No. 7.....
120341	20545	Tweezers (curved) Accessories.....
120344	20545	Oiler (copper plated) with 120345 (Accessories).....
120345	20545	Oiler Spout, 4-1/2 in. long, for 120344 (Accessories).....
120440	20545	Screw Driver (large) Accessories.....
121108	20545	" " (small) Accessories.....
126247	9520	Bench Stand Flush Bolt, for 41538.....
126248	9520	" " " " Plate, for 41538..
126249	20549	Treadle, for 150452.....
126250	20547	" Spring, for 150452.....

No.	Plate	Name
126849	9520	Bench Stand Flap Hinge with four wood screws 3/4 in. No. 7, for 79772.....
127838	20530	Arm Rock Shaft Crank (front) Pin, for 131474.....
128419	20546	Looper Carrier Connection Shaft Oil Pad (braided cotton).....
128510	20532	Balance Wheel Cover.....
131002	20538	Oil Pipe (front of arm) Connection with 131049 and two 198E, for oiling Looper Throw-out Device.....
131003	20538	Oil Pipe (front of arm) Connection with 49189 and two 198E, for 131112 and 131113.....
131004	20538	Oil Pipe (front of arm) Coupling (center)
131004	20538	" " " " " (left)..
131006	20565	Presser Bar Bushing (lower).....
131011	20539	Tension (upper thread) Releasing Shaft Spring Position Plate.....
131012	20542	Tension (under thread) Bracket.....
131022	20547	Machine Base Screw Stud Bushing (rubber) for 131446.....
131025	20566	Slack Thread Controller.....
131028	20646	Looper Driving Shaft and Feed Lifting Eccentric Bushing Oil Plug.....
*131049	-----	Oil Pipe (front of arm) Connection Cap, for 131002.....
131050	20532	Cloth Plate Slide (left) Spring, for 131051.....
131051	-----	Cloth Plate Slide (left) complete for 131389 and 131392, Nos. 68368, 131050 and two 725J.....
131052	20595	Looper Holder with 452C and 1120C.....
131056	20530	Arm Rock Shaft Adjusting Screw Washer....
131060	20598	Feed Dog, 16 teeth (10 teeth to the inch) for 1/32 in. gauge, for 131071, for 147-107 Machine.....
131063	-----	Needle Bar complete, for 1/32 in. gauge, for 147-106 and 147-107 Machines, Nos. 64319 and 131064.....
131064	20594	Needle Clamp with two 50014F, for 1/32 in. gauge, for 131063.....
131065	20594	Needle Guard (stationary).....
131071	20598	Throat Plate, for 1/32 in. gauge, for 131060, for 147-107 Machine.....
131072	20550	Arm Rock Shaft Crank, back (ball bearing, solid) with two 50083C, for 68459....
131084	20538	Oil Pipe (front of arm) Connection with 131085 and two 198E, for 68500.....
*131085	-----	Oil Pipe (front of arm) Connection Cap, for 131084.....

No.	Plate	Name
*131086	-----	Oil Pipe (front of arm) Coupling (right) for 131087.....
131087	20538	Oil Pipe (front of arm) Coupling (right) 131086 with 131088.....
*131088	-----	Oil Pipe (front of arm) Coupling (right) Oil Lead, for 131087.....
131089	20546	Oil Pipe (front of arm) Oil Pad (wick) for 68498 and 68500.....
131095	20550	Arm Rock Shaft Bushing Back Cap Washer (fibre).....
*131110	20551	Looper Driving Shaft and Feed Lifting Eccentric with two 64315, for 131111...
*131111	-----	Looper Driving Shaft and Feed Lifting Eccentric 131110 with 54027, 54227, 54228 and 68479, for 131485, 131488 and 131510.....
131112	20538	Oil Pipe (front of arm) with 68497 and 131003, for oiling Feed Bar Slide Block, for 131258.....
131113	20538	Oil Pipe (front of arm) with 68497 and 131003, for oiling Feed Connecting Rod, for 131258.....
131185	20526	Machine Base Oil Drain Jar (glass) for 131268.....
131188	20526	Machine Base Oil Drain Jar Clamp, for 131217.....
131189	20526	Machine Base Oil Drain Jar Clamp Lever, for 131217.....
131191	20526	Machine Base Oil Drain Jar Cap, for 131268
131197	20551	Feed Bar Hinge Pin (eccentric) for 131398
131198	20561	Presser Bar Spring (auxiliary) complete, Nos. 4604, 131231 and 131232.....
131205	20547	Machine Base Screw Stud, to position machine on base, for 131264.....
131217	-----	Machine Base Oil Drain Jar Clamp 131188 with 131189, for 131268.....
*131231	-----	Presser Bar Spring (auxiliary) for 131198
*131232	-----	" " " " Guide, for 131198.....
131240	20551	Feed Rocking Frame with two 453C, for 131398.....
131258	-----	Oil Pipe (front of arm) complete, Nos. 68498, 68500, 131112 and 131113.....
131263	20549	Machine Base, for 131264.....
131264	-----	Machine Base complete for 131328, Nos. 131263, three each 9842, 51576E, 54477 and four each 131205 and 131279.....
131265	20526	Machine Base Oil Drain Jar Nipple (long) for 131268.....

No.	Plate	Name
131266	20526	Machine Base Oil Drain Jar Nipple (short) for 131268.....
131267	20526	Machine Base Oil Drain Jar Nipple (elbow) for 131268.....
131268	-----	Machine Base Oil Drain Jar (swinging type) complete for 131328, Nos. 131185 131191, 131217, 131266 and two each 1247C, 131265 and 131267.....
131270	20600	Needle Bar Connecting Link Hinge Stud Oil Pad (wick).....
131276	20526	Arm Side Cover (oil vent) for 131278.....
131277	20526	" " " Cap, for 131278.....
131278	-----	Arm Side Cover (oil vent) complete, Nos. 51224W, 131276, 131277 and 131280....
131279	20547	Machine Base Cushion (felt) for 131264...
131280	20530	Arm Side Cover Cap Position Pin, for 131278.....
131291	20594	Needle Bar Bushing (lower).....
131292	20594	Presser Bar Bushing (lower) for 147-108 Machine.....
131293	20550	Arm Rock Shaft, for 131474.....
131305	20529	" Oil Cup Drip Pan with two 563C.....
131309	20529	" " " 68430 with 131310, for filling oil reservoir.....
131310	20529	Arm Oil Cup Oil Tube, for 131309.....
131319	20530	" " " Pad (braided cotton) for 68350.....
131328	-----	Machine Base and Oil Drain Jar (swinging type) complete, Nos. 131264 and 131268
131334	20566	Thread (upper) Take-up, for 131335.....
131335	-----	Thread (upper) Take-up complete, Nos. 1449J 54095, 68164 and 131334.....
131349	-----	Presser Foot Knife, for 131570.....
131356	-----	" " Chaining-off Plate, for 131573.....
131359	-----	Presser Foot Shank, for 131573.....
131366	20550	Arm Rotary Shaft Ball Bearing (back) for 131526.....
131366	20550	Arm Rotary Shaft Ball Bearing (intermediate) for 131526.....
131369	20529	Arm Rotary Shaft Ball Bearing (back) Case Cap, for 131479.....
131370	20530	Arm Rotary Shaft Ball Bearing (back) Case Position Stud.....
131374	20561	Cloth Plate, for 131389 and 131392.....
131376	20599	Cloth Plate Slide (right) 1/16 in. Throat Plate clearance cut, for 131383.....
131379	20599	Cloth Plate Slide (right) 9/64 in. Throat Plate clearance cut, for 131386.....

No.	Plate	Name
131381	20532	Cloth Plate Slide (right) Spring, for 131383 and 131386.....
131383	-----	Cloth Plate Slide (right) complete (1/16 in. Throat Plate clearance cut) for 131389, Nos. 131376, 131381 and two 725J.....
131386	-----	Cloth Plate Slide (right) complete (9/64 in. Throat Plate clearance cut) for 131392, Nos. 131379, 131381 and two 725J.....
131399	-----	Cloth Plate complete, for Throat Plates with 1/16 in. offset, Nos. 131051 131374 and 131383.....
131392	-----	Cloth Plate complete, for Throat Plates with 9/64 in. offset, for 147-105, 147-107 and 147-108 Machines, Nos. 131051, 131374 and 131386.....
131394	20561	Cloth Plate Thread Guard.....
131395	20542	Face Plate (upper half).....
131396	20551	Feed Bar, for 131397.....
131397	20551	Feed Bar complete for 131398, Nos. 50429C 68467, 131396 and two 207E.....
131398	-----	Feed Rocking Frame 131240 with 59343, 131197 and 131397.....
131399	-----	Needle Bar Connecting Link and Thread (upper) Controller 68488 with 68489 and 131400.....
131400	20566	Needle Bar Connecting Stud with 211F and 1492E, for 131399.....
131401	20565	Presser Bar Lifting Bracket with 453C....
131402	20542	" " " Lever.....
131403	20565	Slack Thread Regulator.....
131404	20565	" " " Holder.....
131405	20565	" " " Crank with 171E.....
131406	20565	Slack Thread Regulator Holder Crank Connecting Link.....
131407	20539	Thread (under) Take-up with 1258C.....
131408	20594	" " " Oil Guard, for 131412.....
131409	20594	Thread (under) Take-up Stripper, for 131412.....
131410	20542	Thread (under) Take-up Stripper Plate, for 131412.....
131411	20542	Thread (under) Take-up Stripper Plate Bracket, for 131412.....
131412	-----	Thread (under) Take-up Stripper Plate Bracket 131411 with 32062, 50438J, 54242, 131408 to 131410, 131413 to 131415, two each 207J, 7071, 50470J and four 190J.....

No.	Plate	Name
131413	20594	Thread (under) Take-up Thread Guard (fibre) for 131412.....
131414	20594	Thread (under) Take-up Thread Guide (left) for 131412.....
131415	20594	Thread (under) Take-up Thread Guide (right) for 131412.....
*131446	-----	Arm, upper and lower (solid) with 948J, 15404, 68483, two 15405 and four 131022.....
131456	20550	Arm Rock Shaft Flanged Bushing (front)...
131457	20539	" Rotary Shaft Bushing (front).....
*131471	20550	Crank Connecting Rod with two each 896C and 1057C, for 68459 and 131489.....
131474	-----	Arm Rock Shaft 131293 and 1235F, 127838 and 131475.....
131475	20550	Arm Rock Shaft Crank (front) with 853C, for 131474.....
131476	20599	Arm Rotary Shaft, for 131485.....
131478	20529	" " " Ball Bearing (back) Case, for 131479.....
131479	-----	Arm Rotary Shaft Ball Bearing (back) Case 131478 with 131369 and three 205C, for 131526.....
131480	20539	Arm Rotary Shaft Ball Bearing (back) Spacing Collar, for 131526.....
131481	20550	Arm Rotary Shaft Ball Bearing (intermediate) Case.....
131482	20539	Arm Rotary Shaft Ball Bearing (intermediate) Collar with two 457C.....
131483	20532	Balance Wheel, 2 in. pulley, with two 51283C.....
131485	-----	Arm Rotary Shaft 131476 with 640E, 68459, 131111 and 131502, for 147-104 and 147-106 Machines.....
131486	20594	Arm Rock Shaft Crank, back (ball bearing, solid) with two 50083C, for 131489...
131487	20561	Arm Rotary Shaft, for 131488 and 131510..
131488	-----	" " " 131487 with 640E, 131111 131489 and 131502, for 147-105 and 147-107 Machines.....
131489	-----	Crank Connecting Rod 131471 with 131486, for 131488.....
131500	20551	Feed Connecting Rod with 1057C, 68497, 134260 and two 896C, for 131502.....
131502	-----	Feed Connecting Rod 131500 with 54025, for 131485, 131488 and 131510.....
131510	-----	Arm Rotary Shaft 131487 with 640E, 68459, 131111 and 131502, for 147-108 Machine
131513	-----	Presser Foot Shank, for 131561.....
131526	-----	Arm Rotary Shaft Ball Bearing (back) Case with Ball Bearings complete, Nos. 131479, 131480 and two 131366.....

No.	Plate	Name
131551	20596	Feed Dog, 14 teeth (10 teeth to the inch) for 131558 and 131567.....
13155	20595	Looper (back) closed eye.....
131553	20595	" (front) closed eye.....
131554	-----	Needle Bar complete, Nos. 64319 and 131555
131555	20594	" Clamp with two 50014F, for 131554.
131556	-----	Presser Foot Plate, for 131557.....
131557	20596	Presser Foot (hinged) complete, Nos. 26276 46099 and 131556.....
131558	20596	Throat Plate, for 131551.....
131559	20596	Feed Dog, 12 teeth (8 teeth to the inch) for 131562, for 147-105 and 147-108 Machines.....
131560	-----	Presser Foot Plate, for 131561.....
131561	20596	Presser Foot (hinged) complete, for 147-105 and 147-108 Machines, Nos. 26276, 131513 and 131560.....
131562	20596	Throat Plate, for 131559, for 147-105 and 147-108 Machines.....
131563	20595	Looper (back) closed eye, for 147-106 and 147-107 Machines.....
131564	20595	Looper (front) closed eye, for 147-106 and 147-107 Machines.....
131565	-----	Presser Foot Plate, for 131566.....
131566	20597	Presser Foot (hinged) complete, for 1/32 in. gauge, for 147-106 Machine, Nos. 26276, 46099 and 131565.....
131567	20597	Throat Plate, for 131551, for 147-106 Machine.....
131568	-----	Presser Foot Plate, for 131570.....
131569	-----	" " Shank with 665J, for 131570.
131570	20597	Presser Foot (hinged) with Knife complete for 1/32 in. gauge, for 147-106 Machine, Nos. 239J, 68140, 131349, 131568 and 131569.....
131571	-----	Presser Foot Knife, for 131573.....
131572	-----	" " Plate, for 131573.....
131573	20598	Presser Foot (hinged) with Chaining-off Plate and Knife complete, for 1/32 in. gauge, for 147-107 Machine, Nos. 1296C, 20178, 26276, 131356, 131359, 131571, 131572 and two 220J.....
134258	20533	Feed Bar Slide Block, for 134259.....
134259	20533	" " " " 134258 with 68495 and 134260.....
134260	20533	Feed Bar Slide Block Oil Pad Retainer, for 134259.....
134260	20533	Feed Connecting Rod Oil Pad Retainer, for 131500.....

No.	Plate	Name
138306	20533	Feed Eccentric Lubricating Pad (wood) for 54024.....
139017	20530	Arm Hole Plug Screw Washer.....
*150057	-----	Thread Unwinder Thread Separator, for 150058.....
150058	9505	Thread Unwinder Thread Separator 150057 with 150059, for 150061.....
*150059	-----	Thread Unwinder Thread Separator Bracket, for 150058.....
150060	9505	Thread Unwinder Thread Separator Bracket Arm with 164J and 9525, for 150061...
150061	-----	Thread Unwinder Thread Separator complete for 150062, Nos. 164J, 9525, 150058 and 150060.....
150062	9505	Thread Unwinder complete, Nos. 150061, 201696J, 202490, 225324, 225326, 225388, two 225257, three wood screws 7/8 in. No. 12 and four each 150203 and 225391.....
150203	9505	Thread Unwinder Spool Rest Cushion (felt) for 150062.....
150451	20549	Treadle Stand, for 150452.....
150452	20549	Treadle complete, Nos. 4879, 4882, 126249 126250, 150451 and two wood screws 1 in. No. 16.....
200383C	20546	Thread Unwinder Spool Rest Rod Set Screw, for 202490.....
201018C	20546	Thread Unwinder Spool Rest Set Screw, for 225257.....
201696J	20546	Thread Unwinder Thread Guide Lock Nut, for 150062.....
202490	9505	Thread Unwinder Spool Stand with 200383C, for 150062.....
225257	9505	Thread Unwinder Spool Rest (for two spools) with 201018C, for 150062.....
225322	20546	Thread Unwinder Thread Guide Rod Washer, for 225324.....
225324	9505	Thread Unwinder Thread Guide Rod with 208E and 225322, for 150062.....
225326	20546	Thread Unwinder Thread Guide Position Cup for 150062.....
225388	9505	Thread Unwinder Spool Rest Rod, for 150062
225390	20561	" " Thread Cone Holder, for inverted cones.....
225391	9505	Thread Unwinder Thread Guide, for 150062.

SINGER Needles should be used
in SINGER Machines
These Needles and their Containers
are marked with the
Company's Trade Mark "SIMANCO.***" 1

Needles in Containers marked
"FOR SINGER MACHINES"
are NOT SINGER made needles. 2

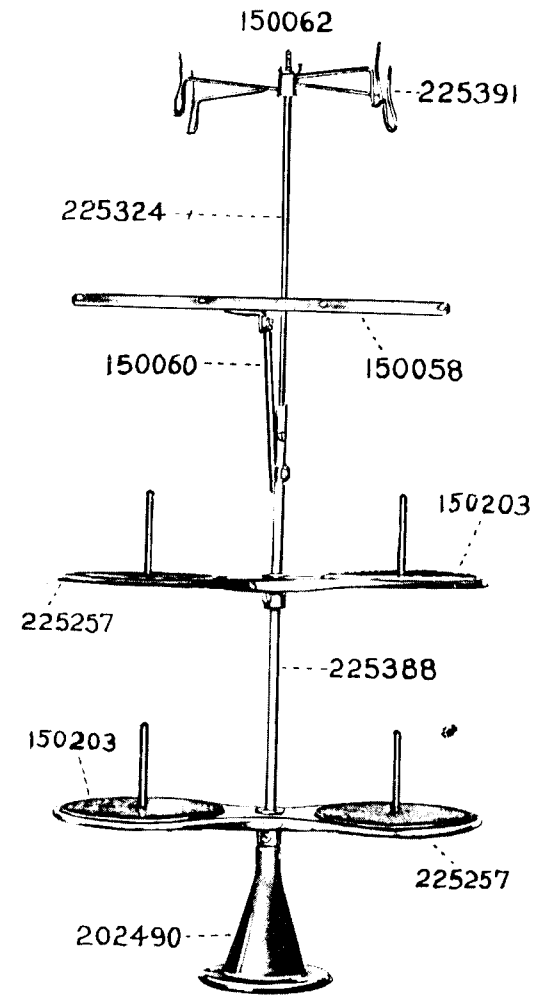
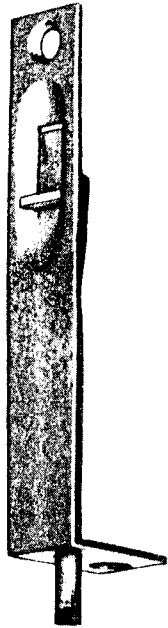
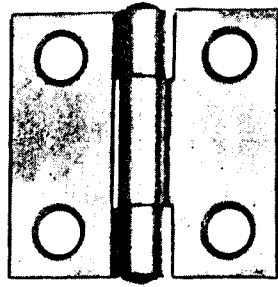


PLATE 9520 - FULL SIZE

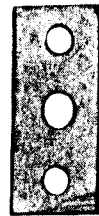
126247



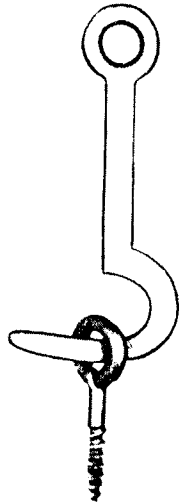
126849



126248



27998



60656

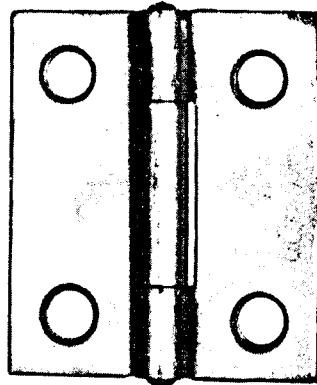
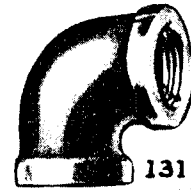


PLATE 20526 - ONE-HALF SIZE

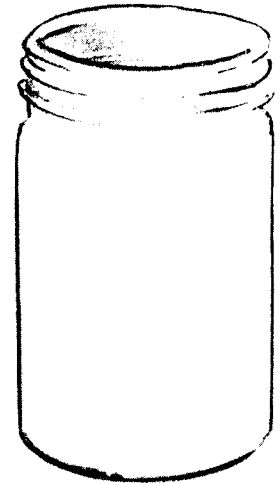
131267



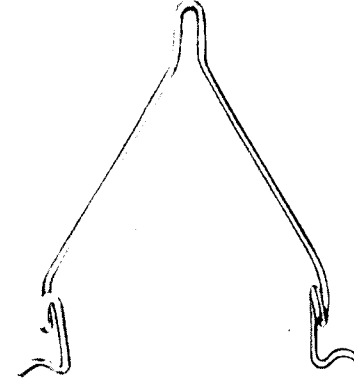
131266



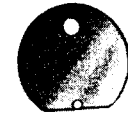
131185



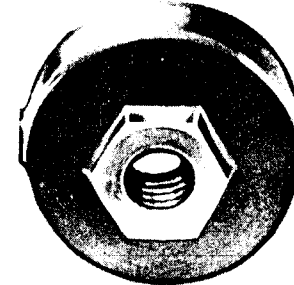
131189



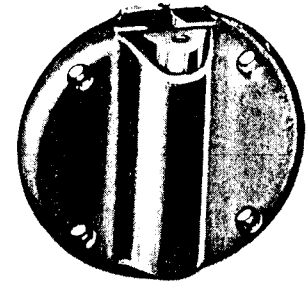
131277



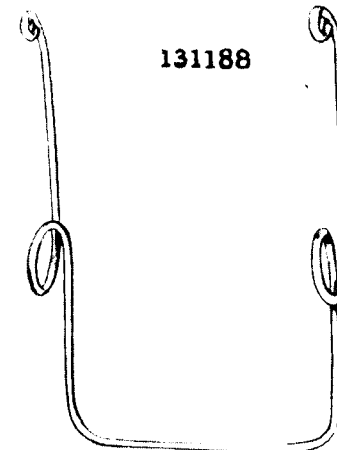
131191



131276



131188



131265



PLATE 20529 - ONE-HALF SIZE

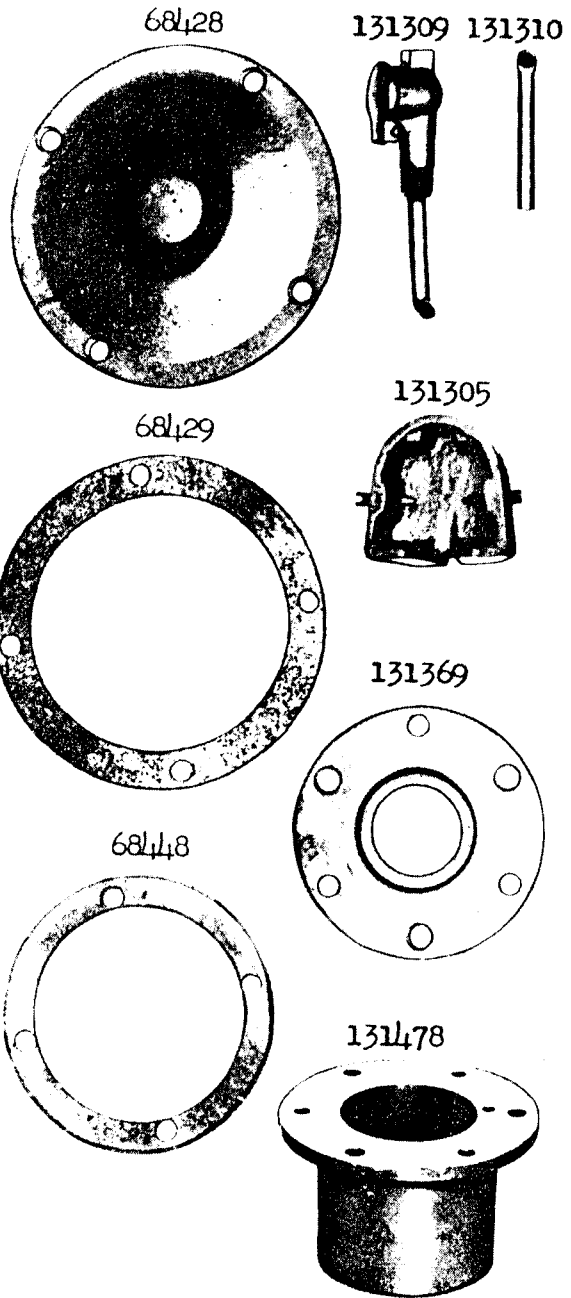
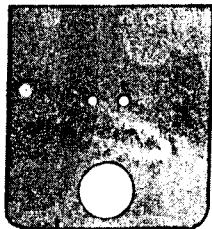


PLATE 20530 - FULL SIZE

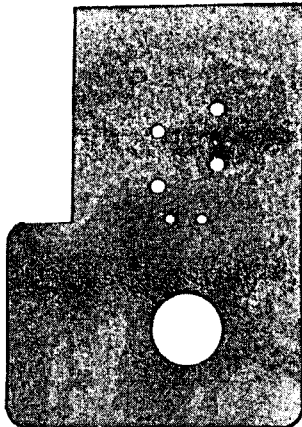


PLATE 20532 - ONE-HALF SIZE

68368



131375



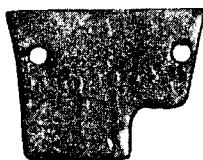
131050



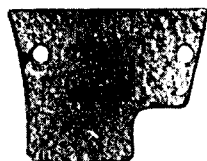
131381



68460



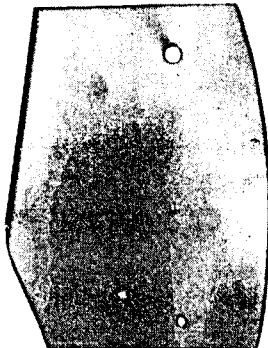
68461



128510



131395



131483

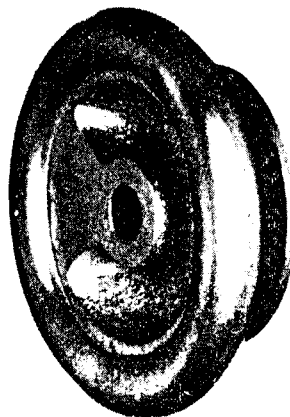


PLATE 20533 - FULL SIZE

207



217



725



7071



50429



330



389



1011



50375



51061



29234



1053



59343



735



50473



157



896



50073



50396



51283



1103



68495



134260



138306



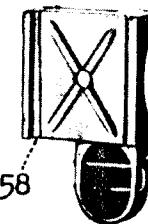
68497



57235



134259



134258



PLATE 20538 - ONE-HALF SIZE

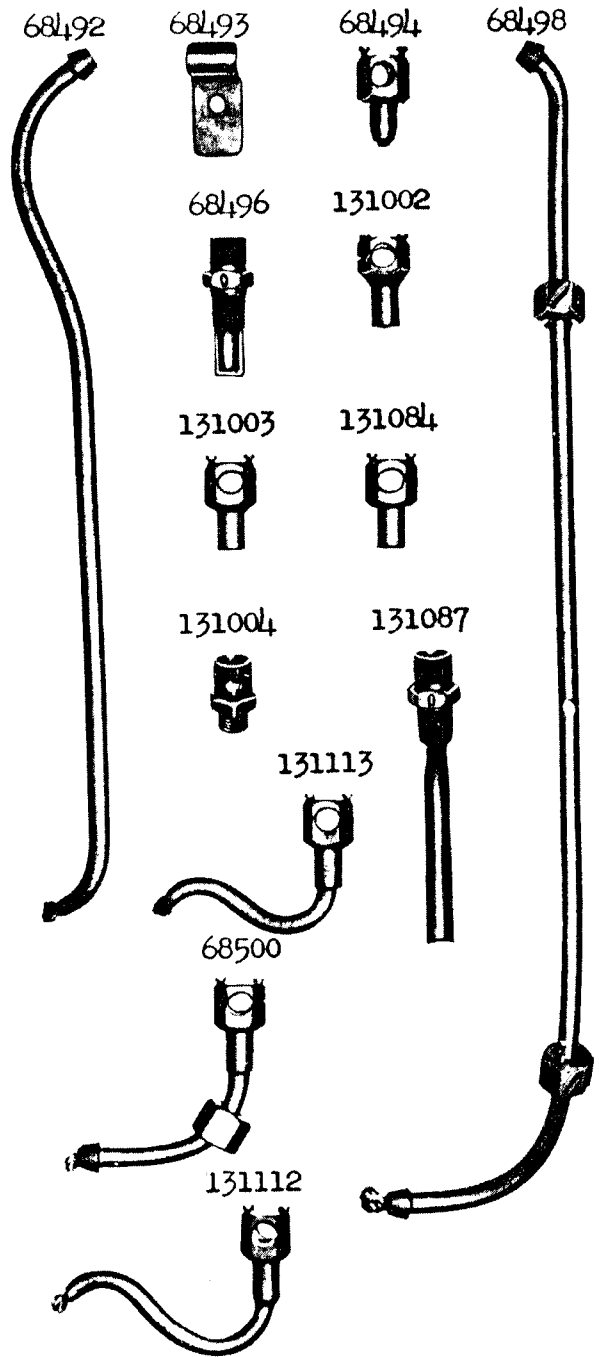


PLATE 20539 - FULL SIZE

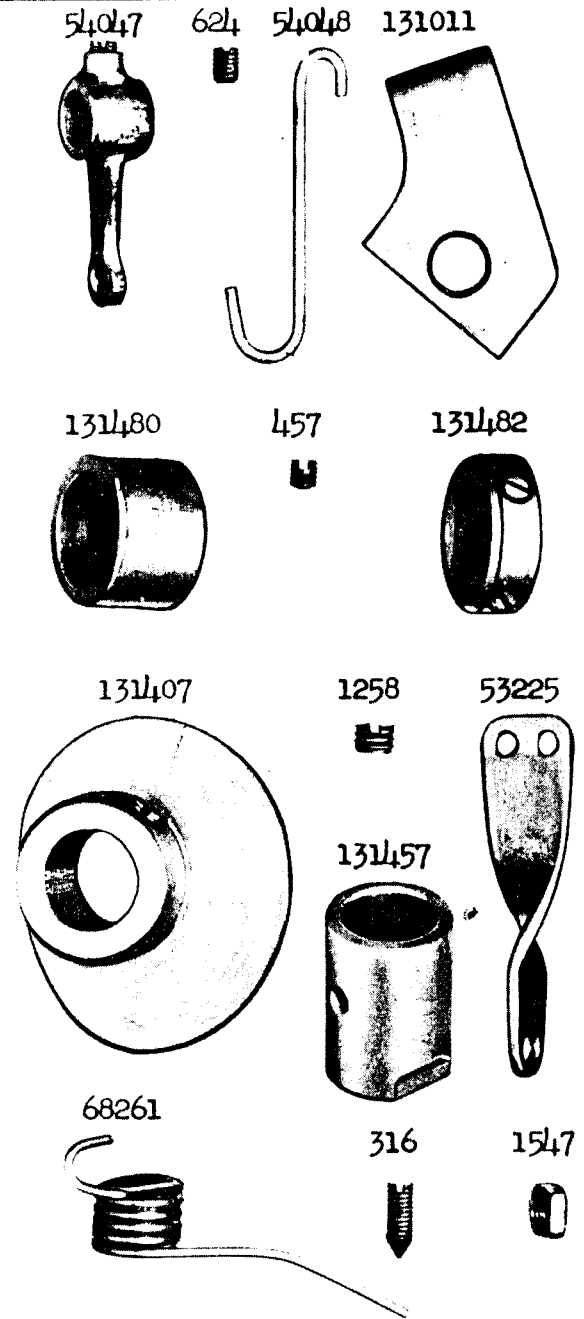


PLATE 20542 - ONE-HALF SIZE

64330



131402



68184



38467



131012



131411



131410

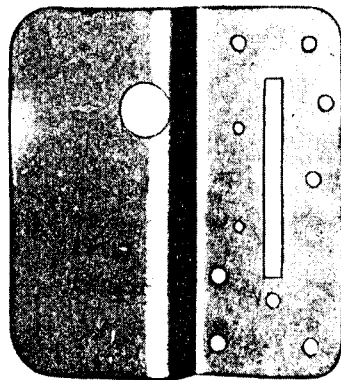


PLATE 20545 - ONE-HALF SIZE

4879



120344



56864



4822



56865



120345



120341 121108

8908

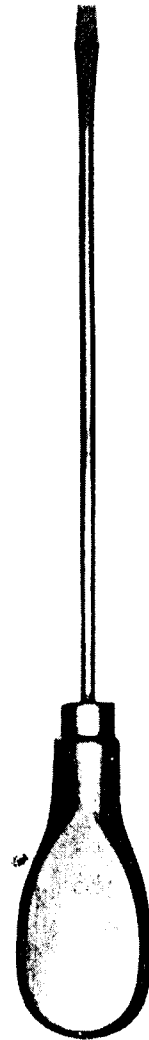
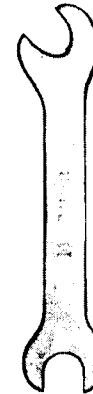


PLATE 20546 - FULL SIZE

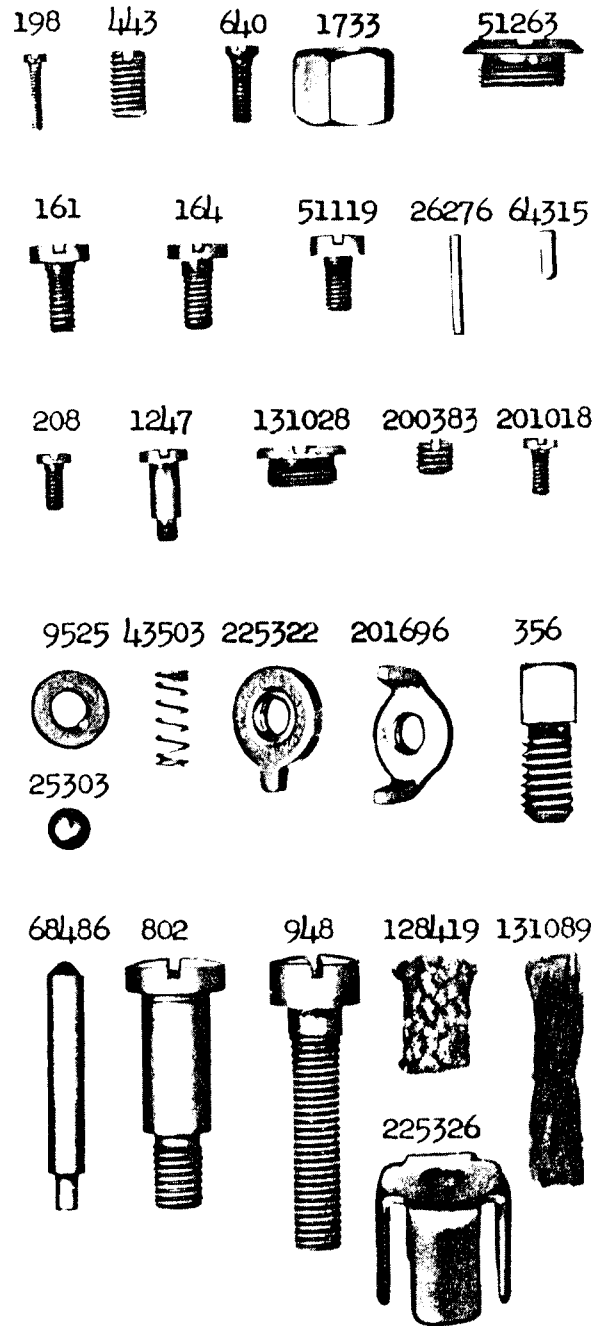


PLATE 20547 - FULL SIZE

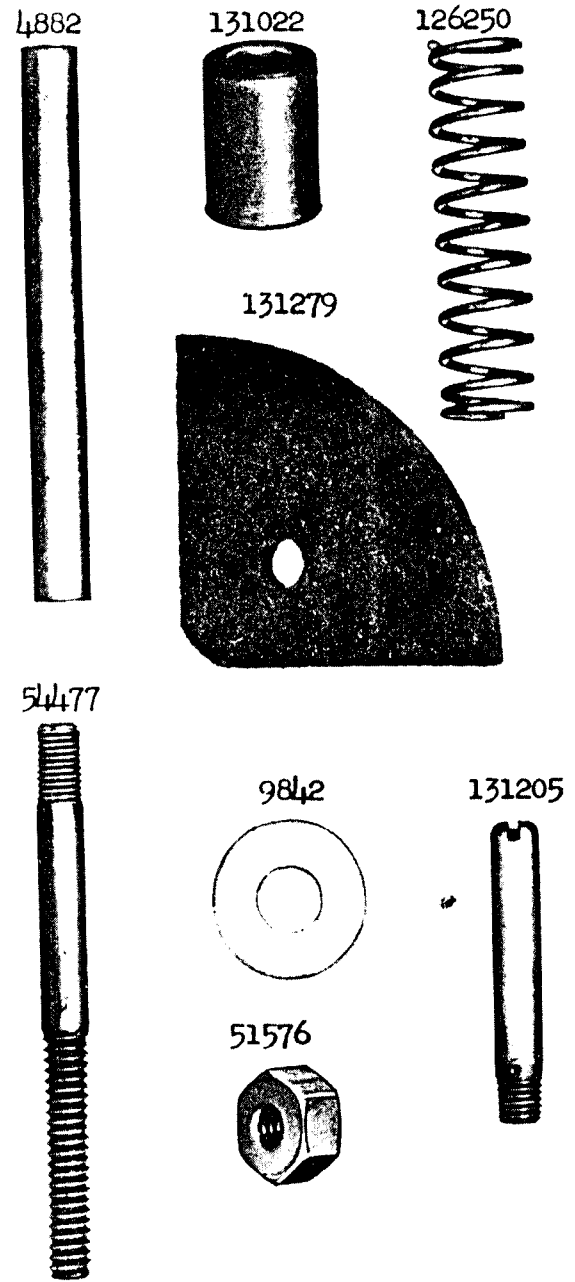
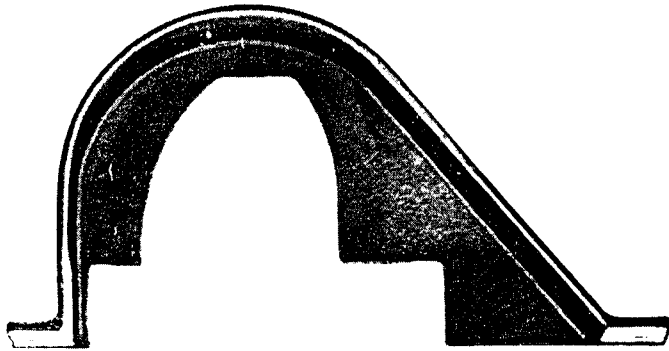
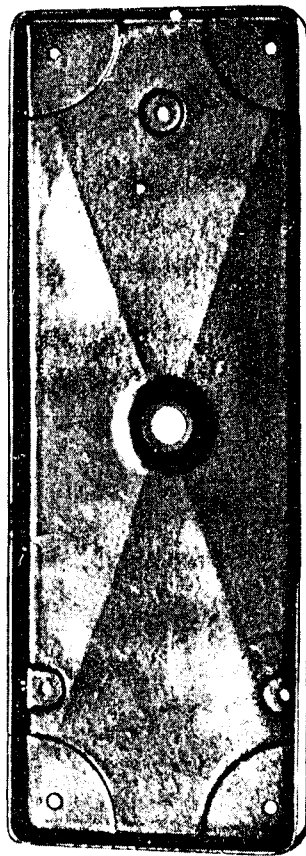


PLATE 20549 - ONE-FOURTH SIZE

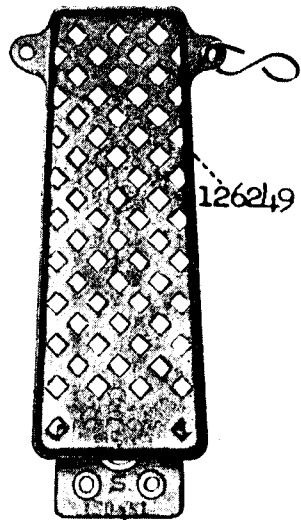
68222



131263



150452



126249

150451

PLATE 20550 - ONE-HALF SIZE

131293



131471



131072



68435



131095



131456



68433



131366



68436



131475

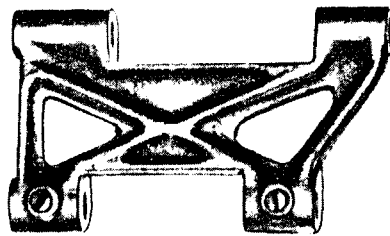


131481

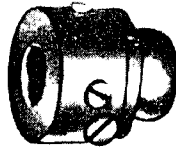


PLATE 20551 - ONE-HALF SIZE

131240



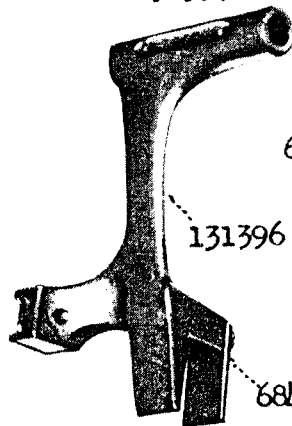
54025



131197 57234



131397



68484

131396

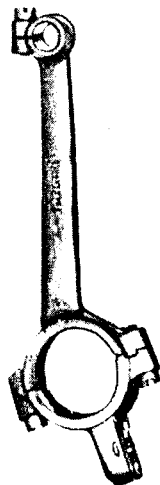


68467

131110



131500



68478

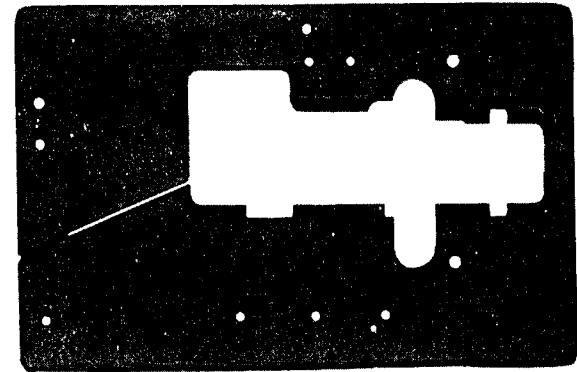


68485

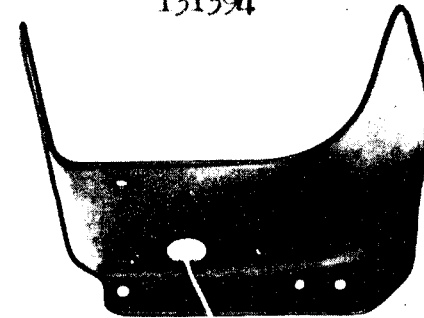


PLATE 20561 - ONE-FOURTH SIZE

131374



131394



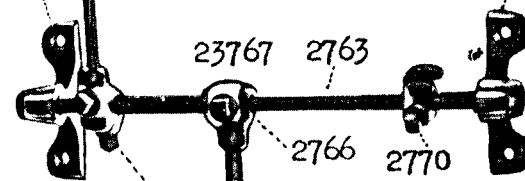
131487



12242

7125

12242



23767

2763

2766

2770

6337

6335

131198

225390

27739



2767



PLATE 20565 - FULL SIZE

131006 38456 11173 38468 50326

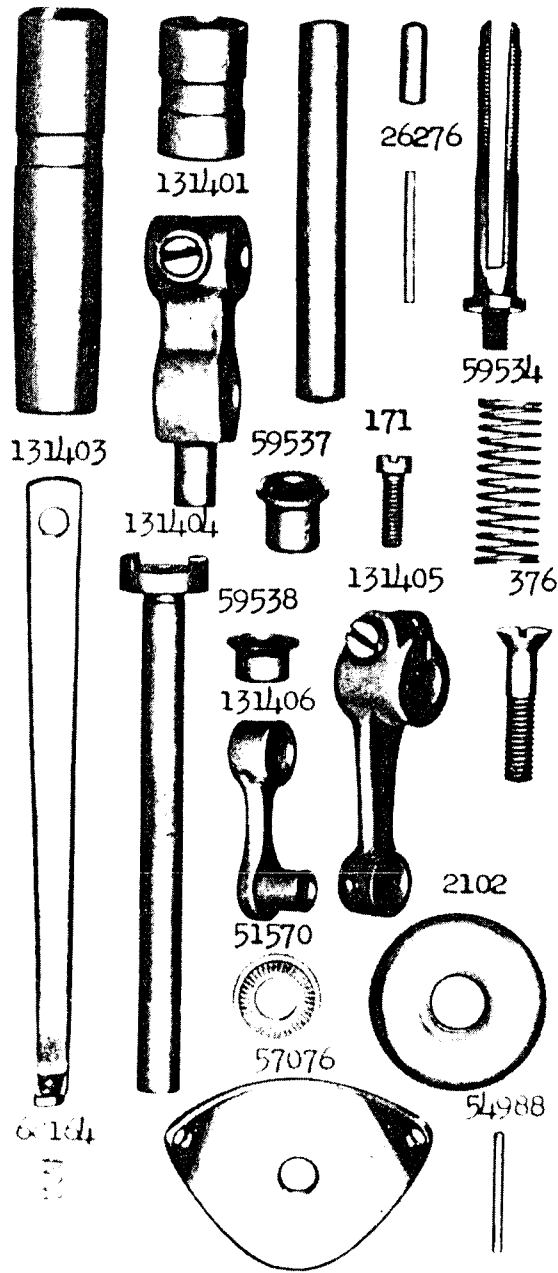


PLATE 20566 - FULL SIZE

64319 54070 131400

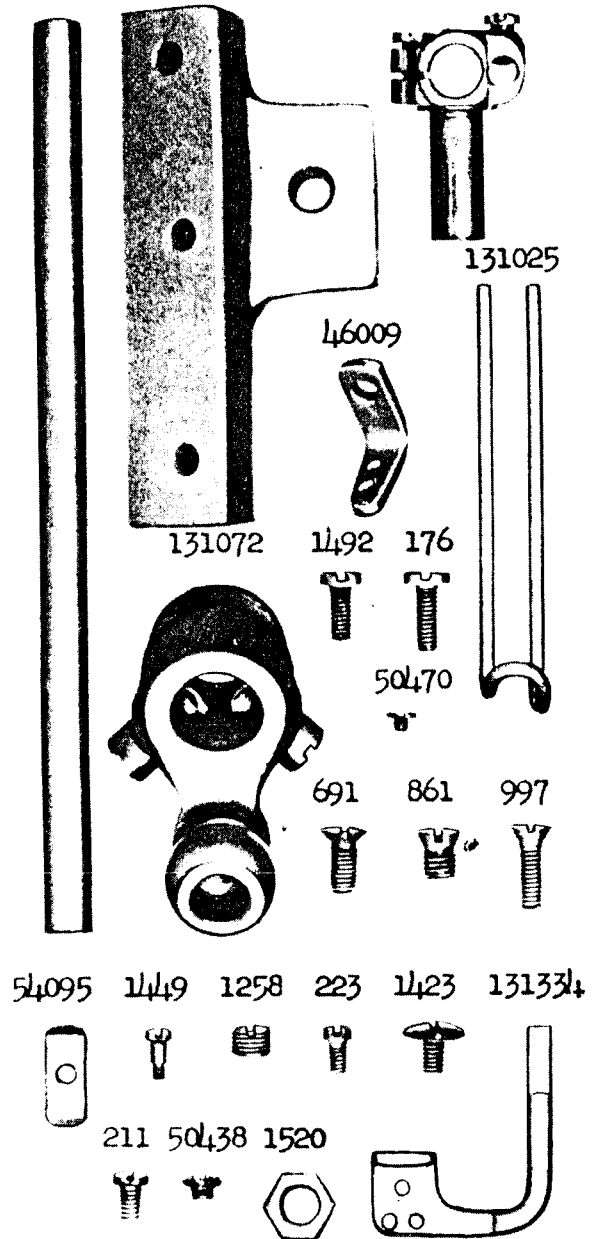


PLATE 20594 - FULL SIZE

54071 131292 54228 64320 131409

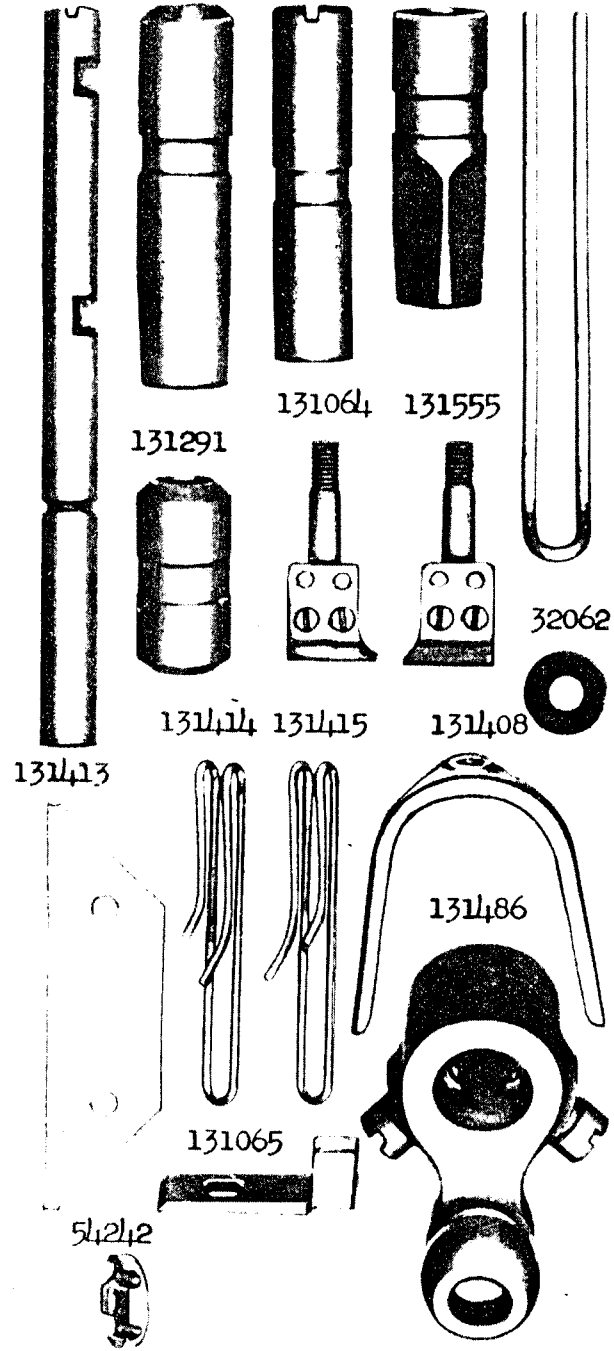


PLATE 20595 - FULL SIZE

68489 131553 131552

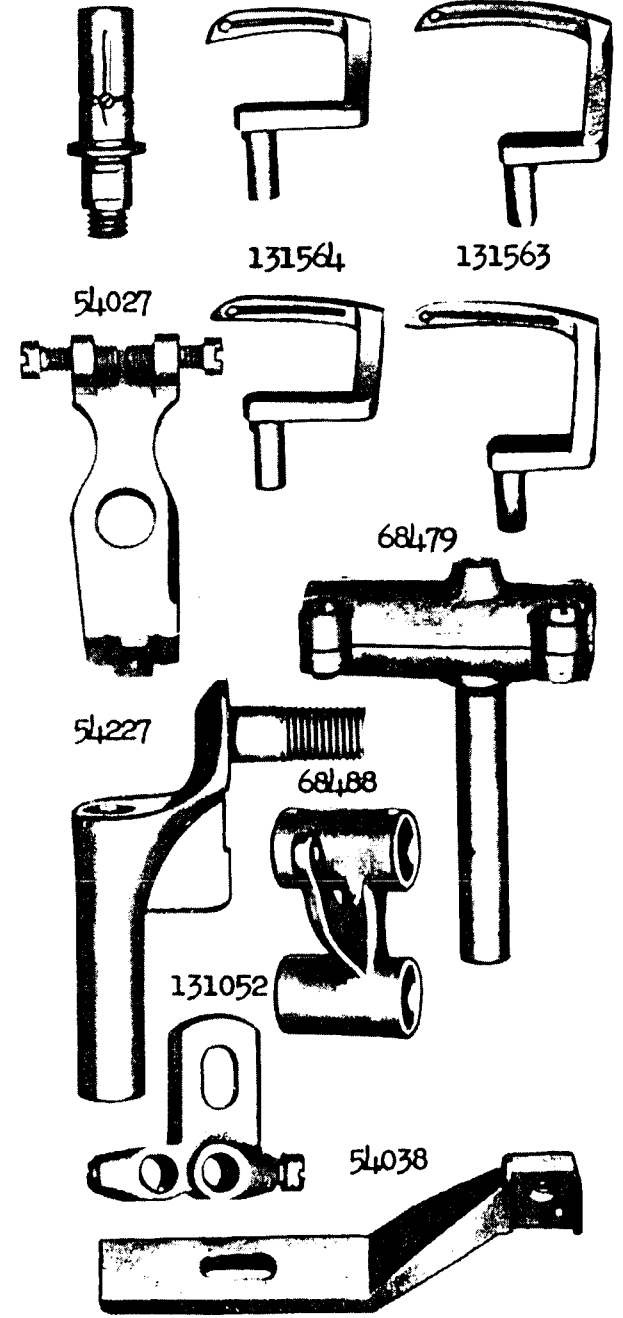
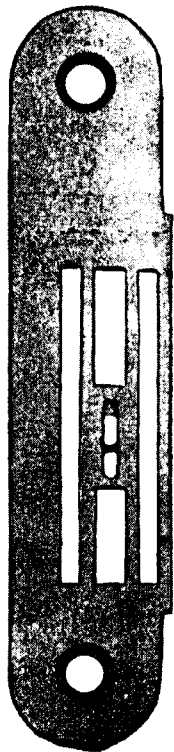
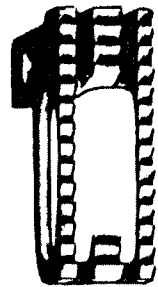


PLATE 20596 - FULL SIZE

131558

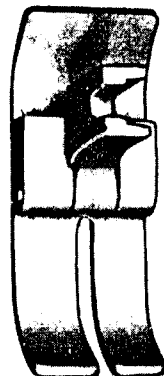


131551

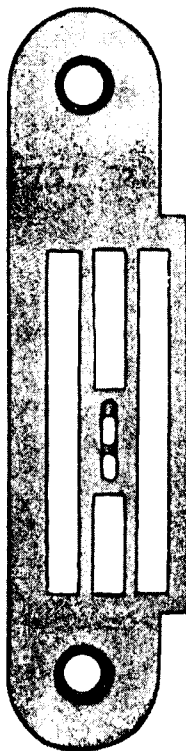


10 teeth =
1 inch

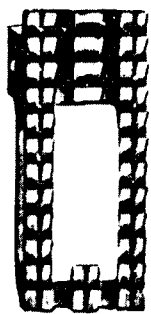
131557



131562



131559



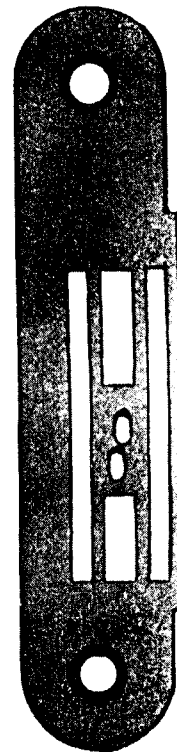
8 teeth = 1 inch

131561

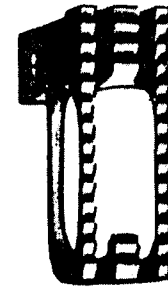


PLATE 20597 - FULL SIZE

131567



131551



10 teeth = 1 inch

131570



131566

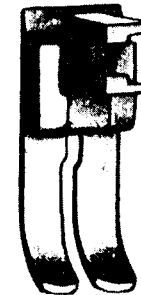
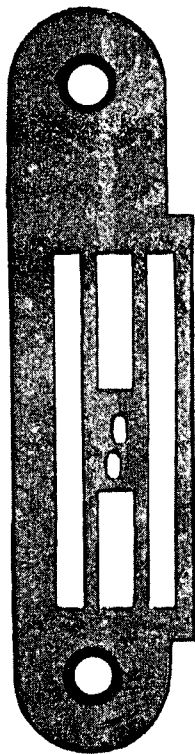
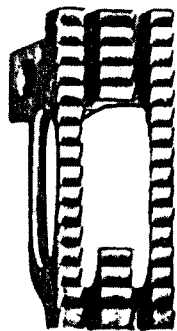


PLATE 20598 - FULL SIZE

131071



131060



10 teeth = 1 inch

131573

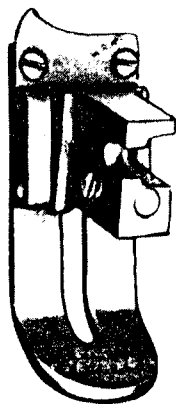
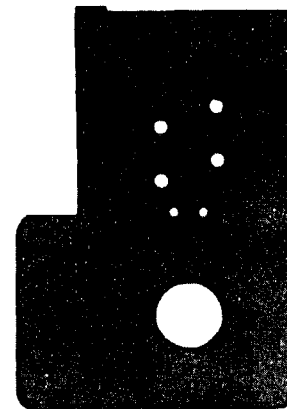
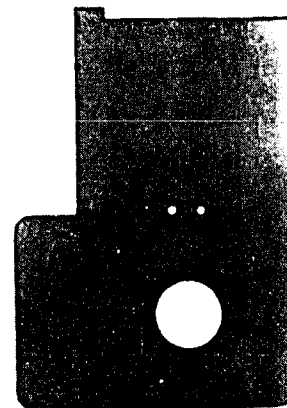


PLATE 20599 - ONE-HALF SIZE



131376



131379



131476

PLATE 20600 - FULL SIZE

